

FusionServer 5885H V7 Server

Technical White Paper

Issue 08
Date 2025-08-28

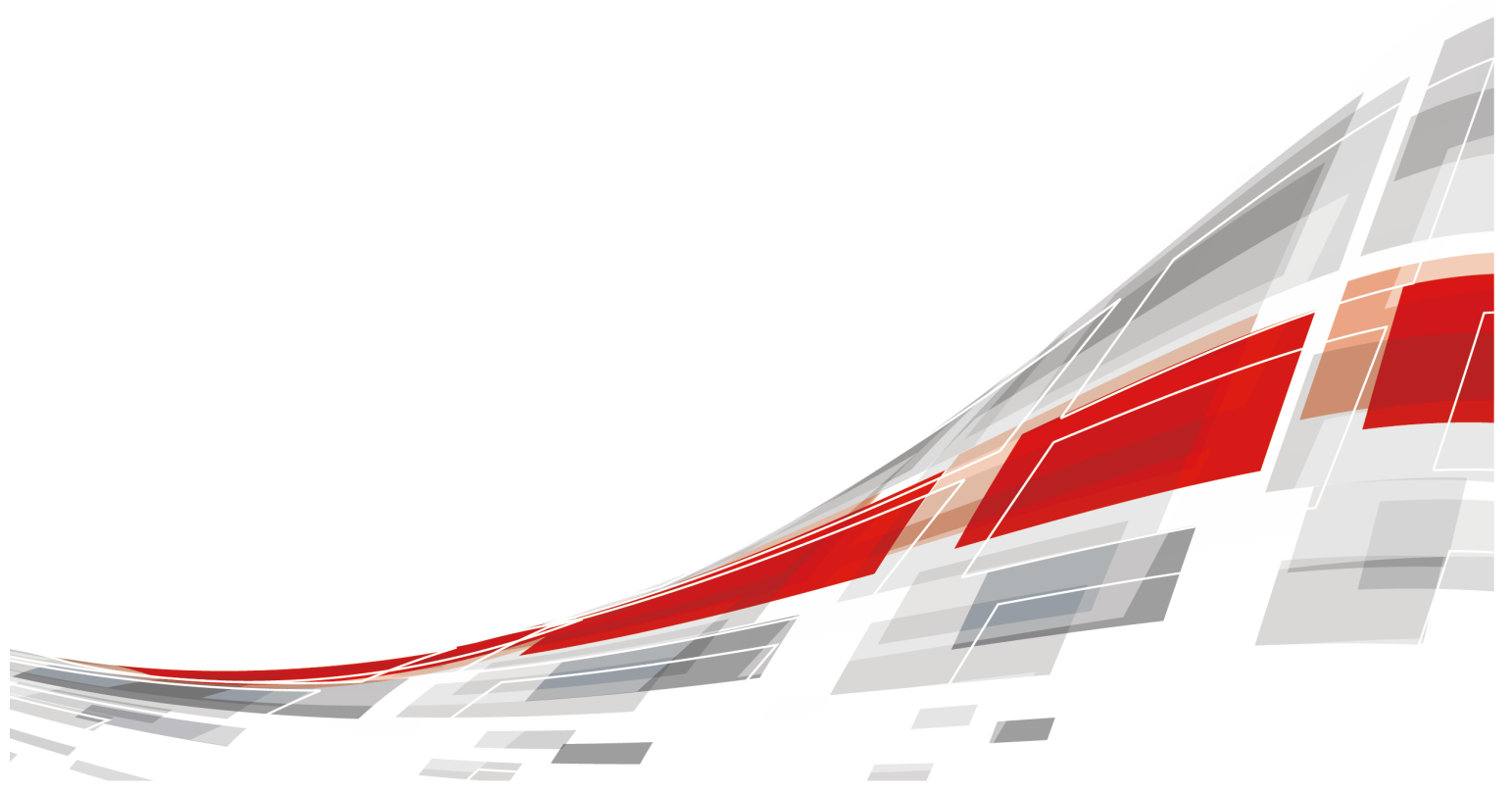

Copyright © XFUSION INTERNATIONAL PTE. LTD. 2025. All rights reserved.

No part of this document may be reproduced or transmitted in any form or by any means without prior written consent of XFUSION INTERNATIONAL PTE. LTD.

Trademarks and Permissions

XFUSION and other xFusion trademarks are trademarks of XFUSION INTERNATIONAL PTE. LTD. All other trademarks and trade names mentioned in this document are the property of their respective holders.

Notice

The purchased products, services and features are stipulated by the contract made between xFusion and the customer. All or part of the products, services and features described in this document may not be within the purchase scope or the usage scope. Unless otherwise specified in the contract, all statements, information, and recommendations in this document are provided "AS IS" without warranties, guarantees or representations of any kind, either express or implied.

The information in this document is subject to change without notice. Every effort has been made in the preparation of this document to ensure accuracy of the contents, but all statements, information, and recommendations in this document do not constitute a warranty of any kind, express or implied.

XFUSION INTERNATIONAL PTE. LTD.

Website: <https://www.xfusion.com>

About This Document

Overview





This document describes the appearance, features, performance parameters, and hardware and software compatibility of FusionServer 5885H V7, so that users can have an in-depth and detailed understanding of FusionServer 5885H V7.

Intended Audience

This document is intended for pre-sales engineers.

Symbolic Conventions

The symbols that may be found in this document are defined as follows:

Symbol	Description
	Indicates a hazard with a high level of risk which, if not avoided, could result in death or serious injury.
	Indicates a hazard with a medium risk which, if not avoided, could result in death or serious injury.
	Indicates a low-level hazard which, if not avoided, could result in minor or moderate injury.
	Indicates a potentially hazardous situation which, if not avoided, could result in device damage, data loss, device performance degradation, or other unpredictable results. NOTICE is used to address practices not related to personal injury.
	Supplements the important information in the main text. NOTE is used to address information not related to personal injury, equipment damage, and environment deterioration.

Change History

Issue	Release Date	Change Description
08	2025-08-28	Added the related content for the cable card supporting 12 x 2.5" drive pass-through configuration 2 (4 x SAS/SATA + 8 x NVMe)
07	2025-04-30	Added A.5 Names and Content of Hazardous Substances .
06	2024-10-31	Updated 5.9 Fan Modules .
05	2024-07-10	Updated 5.2.2 Indicator and 6.2 Environmental Specifications .
04	2023-11-09	<ul style="list-style-type: none"> Updated 10 Certifications. Updated 5.7.2 PCIe Slots: Added the introduction to the riser card connectors.
03	2023-10-30	<ul style="list-style-type: none"> Optimized 5.7.2 PCIe Slots. Updated A.4 Nameplate.
02	2023-08-02	Added the content related to E1.S configuration.
01	2023-05-16	This issue is the first official release.

Contents

About This Document.....	ii
1 Overview.....	1
2 Product Features.....	2
3 Physical Structure.....	5
4 Logic Structure.....	7
5 Hardware Description.....	9
5.1 Front Panel.....	9
5.1.1 Appearance.....	9
5.1.2 Indicators and Buttons.....	13
5.1.3 Ports.....	18
5.2 Rear Panel.....	23
5.2.1 Appearance.....	23
5.2.2 Indicator.....	25
5.2.3 Ports.....	27
5.3 Processors.....	30
5.4 Memory.....	30
5.4.1 DDR5 Memory.....	30
5.4.1.1 Memory Identifier.....	31
5.4.1.2 Memory Subsystem Architecture.....	32
5.4.1.3 Memory Compatibility.....	34
5.4.1.4 Memory Module Installation Rules.....	36
5.4.1.5 Positions of the memory modules.....	36
5.4.1.6 Memory Protection Technologies.....	39
5.5 Storage.....	39
5.5.1 Drive Configuration and Drive Numbering.....	39
5.5.1.1 8 x 2.5" Drive Pass-Through Configuration.....	39
5.5.1.2 12 x 2.5" Drive Pass-Through Configuration.....	44
5.5.1.3 24 x 2.5" Drive Pass-Through Configuration.....	51
5.5.1.4 24 x 2.5" Drive NVMe Configuration.....	55
5.5.1.5 25 x 2.5" Drive EXP Configuration.....	62
5.5.1.6 50 x 2.5" Drive EXP Configuration.....	64

5.5.1.7 49 x 2.5" Drive Configuration.....	67
5.5.2 Drive Indicators.....	70
5.5.3 RAID Controller Card.....	72
5.6 Network.....	73
5.6.1 OCP 3.0 NICs.....	73
5.7 I/O Expansion.....	73
5.7.1 PCIe Cards.....	73
5.7.2 PCIe Slots.....	73
5.7.3 PCIe Slot Description.....	76
5.8 PSUs.....	80
5.9 Fan Modules.....	81
5.10 LCD.....	82
5.11 Boards.....	83
5.11.1 Mainboard.....	84
5.11.2 Drive Backplane.....	86
5.11.3 PSU Backplane.....	93
5.11.4 Fan Board.....	94
5.11.5 M.2 SSD Adapter Board.....	95
6 Product Specifications.....	96
6.1 Technical Specifications.....	96
6.2 Environmental Specifications.....	101
6.3 Physical Specifications.....	103
7 Software and Hardware Compatibility.....	105
8 Safety Instructions.....	106
8.1 Security.....	106
8.2 Maintenance and Warranty.....	109
9 System Management.....	111
10 Certifications.....	113
11 Waste Product Recycling.....	115
A Appendix.....	116
A.1 Chassis Label Information.....	116
A.1.1 Chassis Head Label.....	116
A.1.1.1 Nameplate.....	117
A.1.1.2 Certificate.....	118
A.1.1.3 Quick Access Label.....	119
A.1.2 Chassis Internal Label.....	120
A.1.3 Chassis Tail Label.....	121
A.2 Product SN.....	121
A.3 Operating Temperature Limitations.....	126
A.4 Nameplate.....	134

A.5 Names and Content of Hazardous Substances.....	134
A.6 RAS Features.....	135
A.7 Sensor List.....	135
B Glossary.....	141
B.1 A-E.....	141
B.2 F-J.....	142
B.3 K-O.....	142
B.4 P-T.....	142
B.5 U-Z.....	143
C Acronyms and Abbreviations.....	144
C.1 A-E.....	144
C.2 F-J.....	145
C.3 K-O.....	146
C.4 P-T.....	147
C.5 U-Z.....	149

1 Overview

FusionServer 5885H V7 (5885H V7) is a 4U 4-socket rack server designed for the Internet Data Center (IDC), cloud computing, enterprise business, and telecom.

This product is ideal for various applications, such as databases, cloud computing, virtualization, and in-memory computing.

This product features high-performance computing, large-capacity storage, low power consumption, high scalability, high reliability, and easy management and deployment, and high virtualization application density.

 **NOTE**

For details about the server nameplate, see [A.4 Nameplate](#).

Figure 1-1 Server with 8 x 3.5" drives (example)

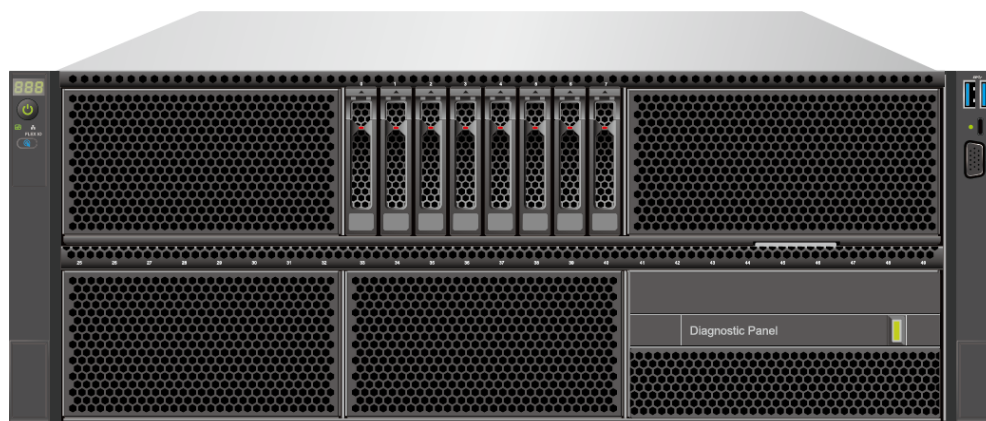

2 Product Features

Performance

- The server supports the new generation of Intel® Xeon® Scalable processors (Sapphire Rapids). A processor provides up to 60 cores and 120 threads, up to 350 W TDP, a maximum of 4.2 GHz turbo frequency, 2 MB L2 cache and 1.875 MB L3 cache, and three groups of 16 GT/s UPI links between the processors, which deliver supreme processing performance.
- The server supports a maximum of 64 DDR5 4800 MT/s registered dual-inline memory modules (RDIMMs), delivering up to 16 TB total memory capacity (calculated using the maximum capacity of a single memory module: 256 GB). The memory modules feature high speed and availability.

Scalability

- Flexible drive configurations cater to a variety of business requirements and ensure high elasticity and scalability of storage resources.
- Up to 50 x 2.5" front drives + 2 x 2.5" rear drives.
- The server supports a maximum of 21 standard PCIe slots. Among these slots, a maximum of ten can be PCIe x16 slots, six of which support PCIe 5.0.
- Supports one GE/10GE/25GE/100GE OCP 3.0 NIC that supports orderly hot swap.

NOTE

A hot swap of an OCP NIC requires support of related OS drivers. Ensure that the OS is started and the OCP hot swap-related drivers have been loaded before performing a hot swap of an OCP NIC.

Availability and Serviceability

- Carrier-class components with process expertise ensure high system reliability and availability.
- The server uses hot-swappable SAS/SATA/NVMe drives. It supports RAID 0, 1, 1E, 10, 5, 50, 6, and 60, depending on the RAID controller card used. It also uses a supercapacitor to protect the RAID cache data against power failures.
- The panel provides a UID/Healthy LED indicator, fault diagnosis LCD, and fault diagnosis LCD touch panel. The iBMC Web management interface provides key component status indications. The iBMC web management interface helps

technical personnel quickly find faulty components or the components with risk of faults, simplifying maintenance, speeding up troubleshooting, and improving system availability.

- The mounting ear provides the iBMC direct connect management port to support local iBMC O&M, improving O&M efficiency.
- A server provides four hot-swappable PSUs in N+N redundancy mode. A server provides six or eight hot-swappable fan modules in N+1 redundancy mode, improving system availability.
- The intelligent Baseboard Management Controller (iBMC) can continuously monitor system parameters, trigger alarms, and take recovery measures to minimize shutdown.

Manageability and Security

- The built-in iBMC monitors server operating status and provides remote management.
- Supports BIOS menu passwords to ensure the security of system startup and system management.
- Supports the Network Controller Sideband Interface (NC-SI) feature that allows a network port to provide functions of both a management network port and a service network port. The NC-SI feature can be enabled or disabled through the iBMC or BIOS. The NC-SI feature is disabled by default.

NOTE

The service network port of the NC-SI feature supports the following configurations:

- It can be bound to any network port of the server's OCP 3.0 NIC or other standard PCIe NICs that support the NC-SI function.
- It allows users to enable or disable the virtual local area network ID (VLAN ID) and configure the VLAN ID. The VLAN ID is **0** and disabled by default.
- It supports IPv4 and IPv6 addresses, and allows users to configure the IP address, subnet mask, default gateway, or prefix length of an IPv6 address.
- The integrated Unified Extensible Firmware Interface (UEFI) improves setup, configuration, and update efficiency and simplifies fault clearance.
- Supports the lockable server front bezel to ensure local data security.
- Intel Execute Disable Bit (EDB) function prevents certain types of malicious buffer overflow attacks when working with a supported OS.
- Intel® Converged Boot Guard & Trusted Execution Technology defends against malicious software attacks based on hardware, prevents device firmware from being maliciously modified, and prevents unauthorized boot block execution. The technology allows applications to run in their own independent space, freeing them from other software running in the system and enhancing security.
- Supports the trusted platform module (TPM) and trusted password module (TCM) to provide advanced encryption functions, such as digital signature and remote authentication.
- Meets the following requirements in NIST SP 800-147B:
 - The BIOS firmware digital signature update mechanism is supported. During the upgrade, the digital signature is verified to prevent unauthorized BIOS firmware upgrade.

- The flash security protection mechanism is supported to prevent unauthorized modification of the flash in the OS.

Energy Efficiency

- Provides 80 Plus Platinum/Titanium PSUs with different energy efficiency levels. The efficiency of the PSUs reaches 96% when the load is 50%.
- Efficient Voltage Regulator Down (VRD) power supplies for boards minimize the energy loss from DC/DC power conversion.
- Area-based Proportional-Integral-Derivative (PID) intelligent fan speed adjustment and intelligent CPU frequency scaling optimize heat dissipation and reduce overall system power consumption.
- The improved thermal design with energy-efficient fans ensures optimal heat dissipation and reduces system power consumption.
- The server is protected with power capping and power control measures.
- Staggered spinup of drives reduces the server boot power consumption.
- Intel Intelligent Power Capability allows a processor to be powered on or off based on service requirements.
- Low-voltage Intel® Xeon® Scalable processors consume less energy, ideally suited for data centers and telecommunications environments constrained by power and thermal limitations.
- The power consumption of SSDs is 80% lower than that of traditional HDDs. You are advised to use SSDs.

3 Physical Structure

Figure 3-1 Physical structure of a server with 8 x 2.5" drives (example)

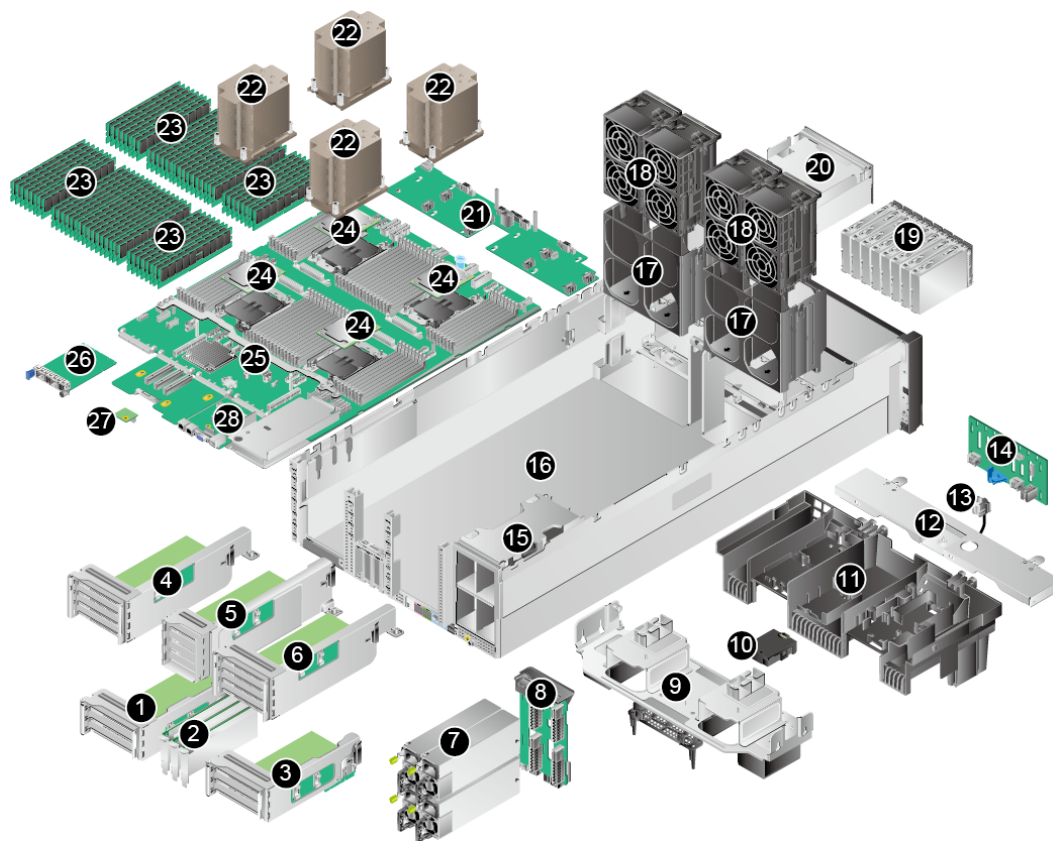

1	I/O module 1	2	PCIe card
3	I/O module 2	4	I/O module 3
5	I/O module 4	6	I/O module 5
7	PSUs	8	PSU backplane
9	Typical configuration beam	10	Supercapacitor and its holder

11	Air duct	12	Beam with lock
13	Intrusion sensor	14	Front drive backplane
15	Power shelf	16	Chassis
17	Fan module bracket	18	Fan module
19	Front drive	20	LCD (optional)
21	Fan board	22	Processor heat sink
23	Memory	24	Processor
25	Mainboard	26	OCP3.0 NIC
27	TPM/TCM	28	BMC card

4 Logic Structure

Figure 4-1 Logic structure

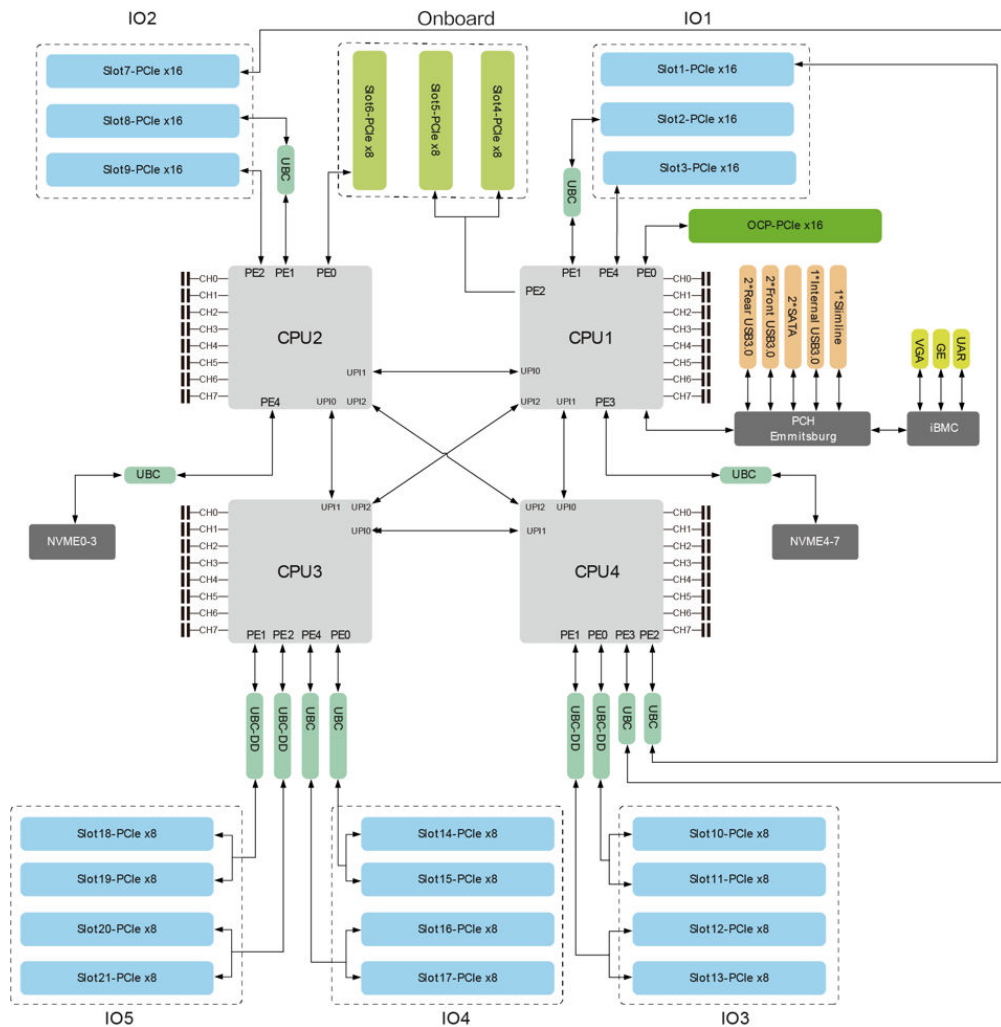

- The server supports two or four new-generation Intel® Xeon® Scalable processors (Sapphire Rapids).
- It supports 64 DDR5 DIMMs.

- The processors interconnect with each other through three UltraPath Interconnect (UPI) links at a speed of up to 16 GT/s.
- Supports 21 standard PCIe slots of various specifications.
- Supports one OCP 3.0 NIC.
- Supports low-speed I/O ports, such as VGA, USB 3.0, and serial port (RJ45).
- The BMC card integrates the BMC management chip and provides external video graphic array (VGA), management network port, and serial port.

5 Hardware Description

- 5.1 Front Panel
- 5.2 Rear Panel
- 5.3 Processors
- 5.4 Memory
- 5.5 Storage
- 5.6 Network
- 5.7 I/O Expansion
- 5.8 PSUs
- 5.9 Fan Modules
- 5.10 LCD
- 5.11 Boards

5.1 Front Panel

5.1.1 Appearance

- 8 x 2.5" drive pass-through configuration (8 x SAS/SATA)

Figure 5-1 Front view

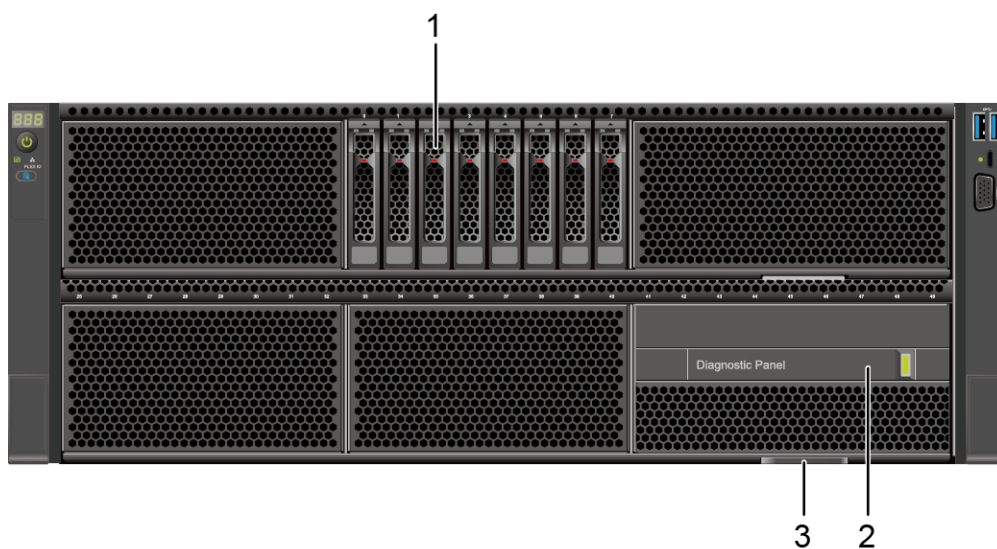

1	SAS/SATA drives	2	(Optional) LCD module
3	Slide-out label plate (with an SN label)	-	-

- 12 x 2.5" drive pass-through configuration (4 x SAS/SATA + 8 x NVMe)

Figure 5-2 Front view

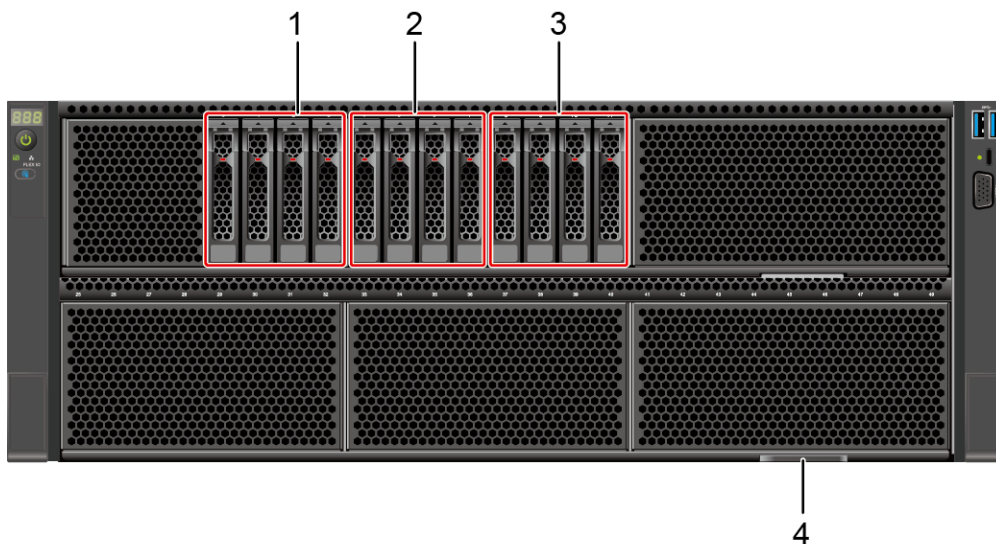

1	SAS/SATA drives	2	SAS/SATA/NVMe drives
3	NVMe drives	4	Slide-out label plate (with an SN label)

- 24 x 2.5" drive pass-through configuration (24 x SAS/SATA)

Figure 5-3 Front view

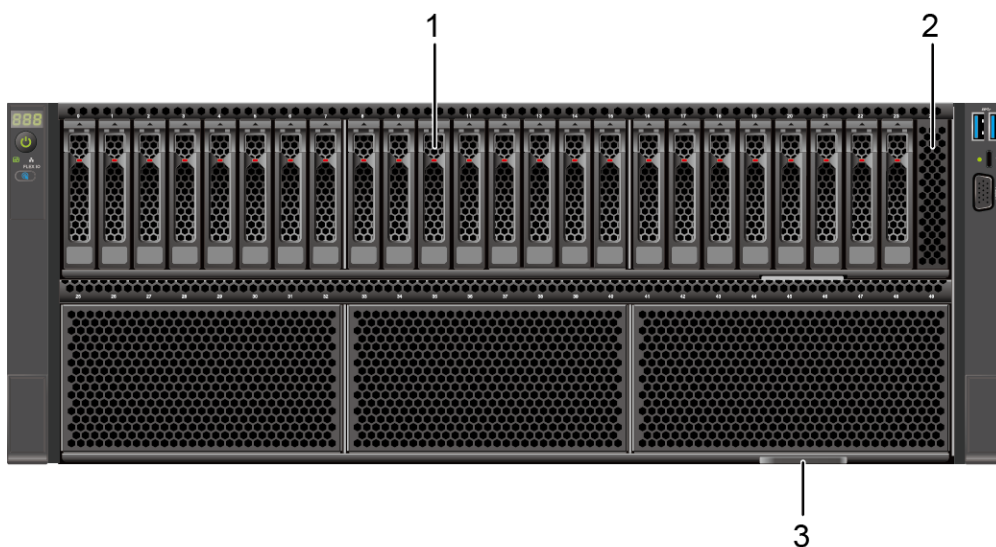

1	SAS/SATA drives	2	Drive slot filler panel NOTE Drives cannot be installed in the slot.
3	Slide-out label plate (with an SN label)	-	-

- 25 x 2.5" drive EXP configuration (25 x SAS/SATA)

Figure 5-4 Front view

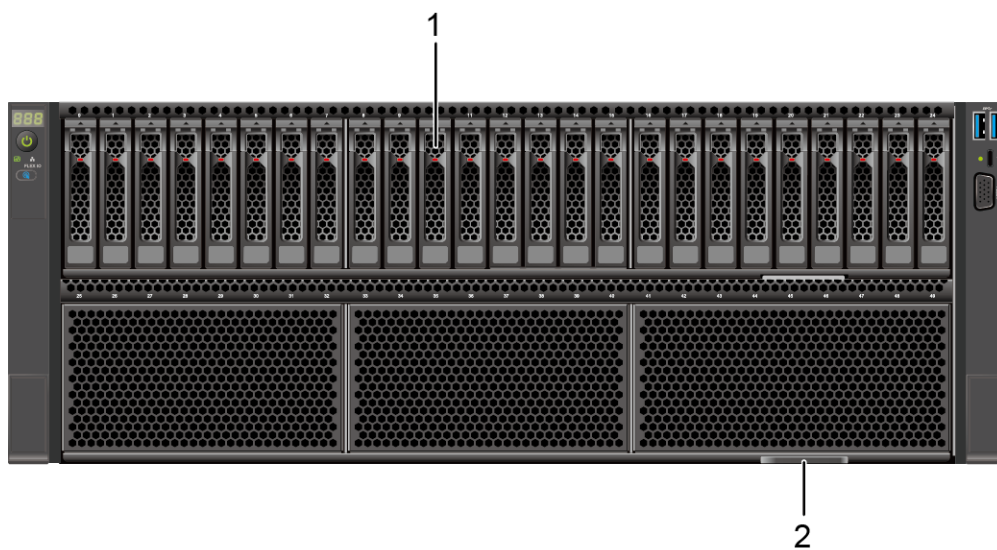

1	SAS/SATA drives	2	Slide-out label plate (with an SN label)
---	-----------------	---	--

- 24 x 2.5" drive pass-through configuration (24 x NVMe)

Figure 5-5 Front view

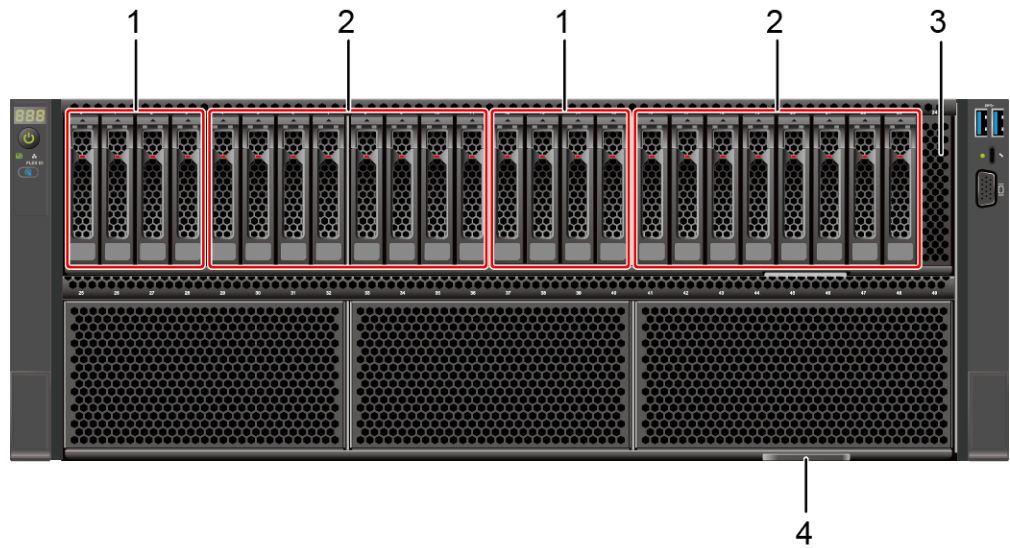

1	SAS/SATA/NVMe drives	2	NVMe drives
3	Drive slot filler panel NOTE Drives cannot be installed in the slot.	4	Slide-out label plate (with an SN label)

- 49 x 2.5" drive configuration (25 x SAS/SATA + 24 x NVMe)

Figure 5-6 Front view

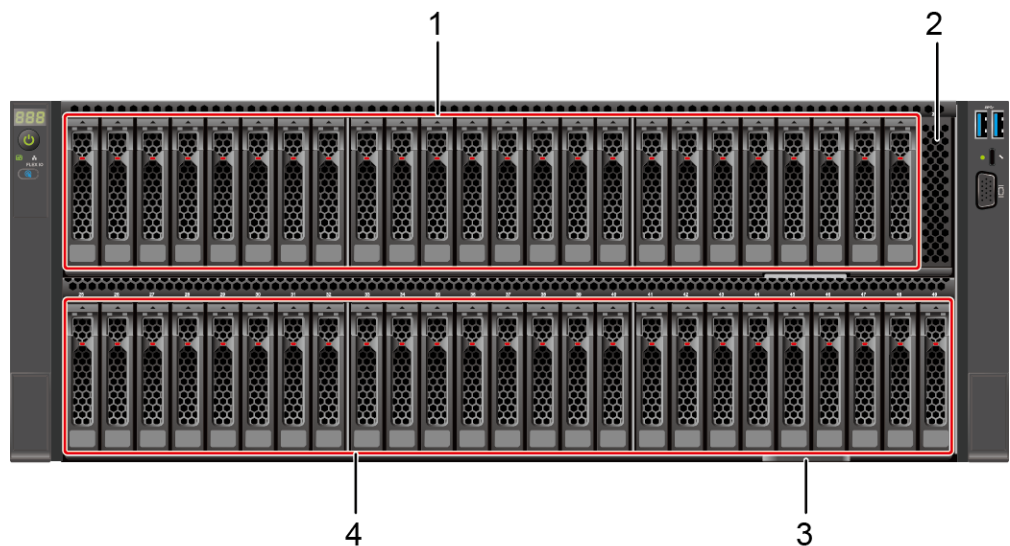

1	NVMe drives	2	Drive slot filler panel NOTE Drives cannot be installed in the slot.
---	-------------	---	---

3	Slide-out label plate (with an SN label)	4	SAS/SATA drives
---	--	---	-----------------

- 50 x 2.5" drive configuration (50 x SAS/SATA)

Figure 5-7 Front view

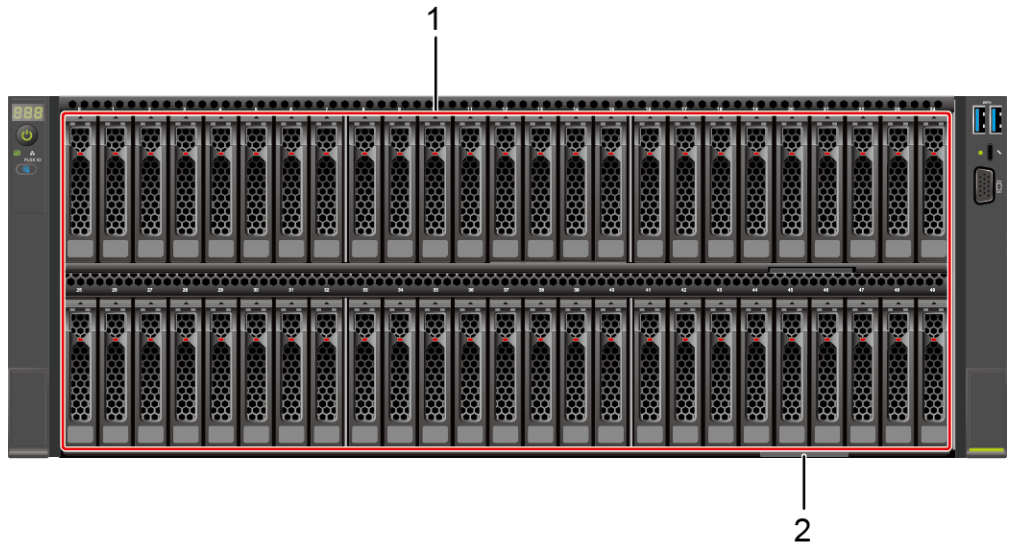

1	SAS/SATA drives	2	Slide-out label plate (with an SN label)
---	-----------------	---	--

5.1.2 Indicators and Buttons

Indicator and Button Positions

- 8 x 2.5" drive pass-through configuration (8 x SAS/SATA)

Figure 5-8 Indicators and buttons on the front panel

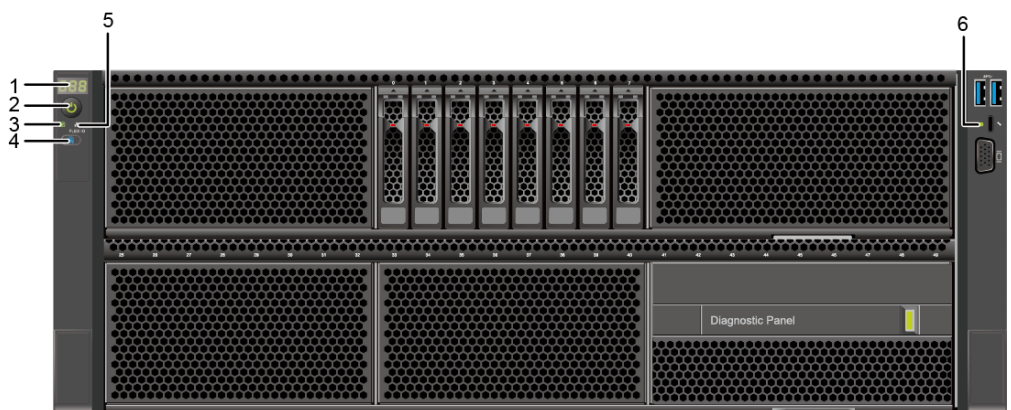

1	Fault diagnosis LED	2	Power button/indicator
3	Health status indicator	4	UID button/indicator
5	FlexIO card presence indicator	6	iBMC direct connect management port indicator

- 12 x 2.5" drive pass-through configuration (4 x SAS/SATA + 8 x NVMe)

Figure 5-9 Indicators and buttons on the front panel

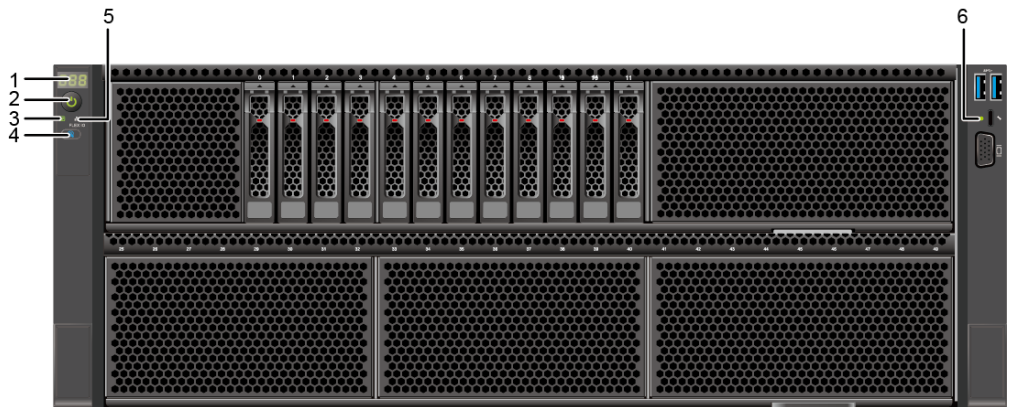

1	Fault diagnosis LED	2	Power button/indicator
3	Health status indicator	4	UID button/indicator
5	FlexIO card presence indicator	6	iBMC direct connect management port indicator

- 24 x 2.5" drive pass-through configuration (24 x SAS/SATA)

Figure 5-10 Indicators and buttons on the front panel

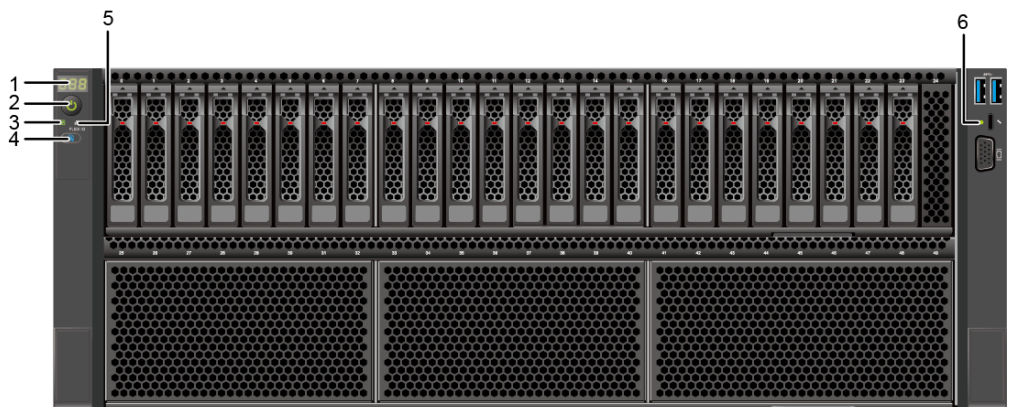

1	Fault diagnosis LED	2	Power button/indicator
3	Health status indicator	4	UID button/indicator
5	FlexIO card presence indicator	6	iBMC direct connect management port indicator

- 24 x 2.5" drive pass-through configuration (24 x NVMe)

Figure 5-11 Indicators and buttons on the front panel

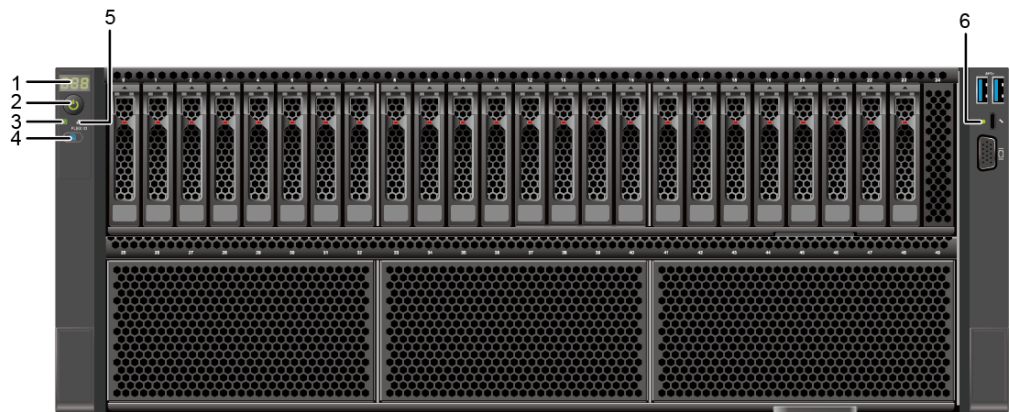

1	Fault diagnosis LED	2	Power button/indicator
3	Health status indicator	4	UID button/indicator
5	FlexIO card presence indicator	6	iBMC direct connect management port indicator

- 25 x 2.5" drive EXP configuration (25 x SAS/SATA)

Figure 5-12 Indicators and buttons on the front panel

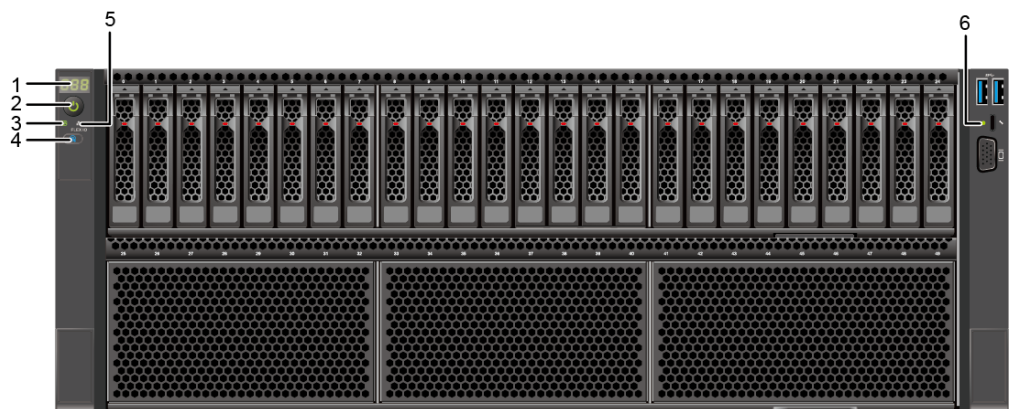

1	Fault diagnosis LED	2	Power button/indicator
3	Health status indicator	4	UID button/indicator
5	FlexIO card presence indicator	6	iBMC direct connect management port indicator

- 50 x 2.5" drive configuration (50 x SAS/SATA)

Figure 5-13 Indicators and buttons on the front panel



1	Fault diagnosis LED	2	Power button/indicator
3	Health status indicator	4	UID button/indicator
5	FlexIO card presence indicator	6	iBMC direct connect management port indicator

- 49 x 2.5" drive configuration (25 x SAS/SATA + 24 x NVMe)

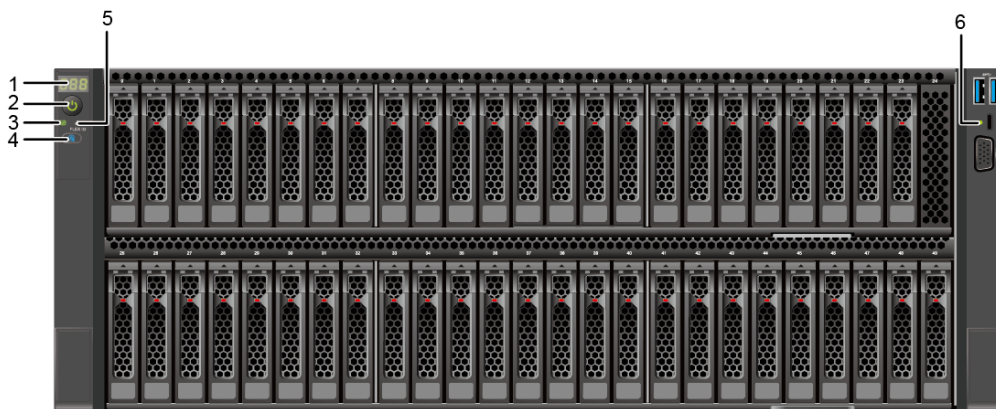

Figure 5-14 Indicators and buttons on the front panel







1	Fault diagnosis LED	2	Power button/indicator
3	Health status indicator	4	UID button/indicator
5	FlexIO card presence indicator	6	iBMC direct connect management port indicator

Indicator and Button Descriptions

Table 5-1 Description of indicators and buttons on the front panel

Sign	Indicators and Buttons	Description
	Fault diagnosis LED	<ul style="list-style-type: none"> ---: The device is operating properly. Error code: A component is faulty. For details about fault codes, see the <i>BMC Alarm Handling</i>.
	Power button/indicator	<p>Power indicator:</p> <ul style="list-style-type: none"> Off: The device is powered off. Steady green: The device is powered on. Blinking yellow: The iBMC is starting. The power button is locked and cannot be pressed. The iBMC is started in about 1 minute, and then the power indicator is steady yellow. Steady yellow: The device is in the standby state. <p>Power button:</p> <ul style="list-style-type: none"> When the device is powered on, you can press this button to gracefully shut down the OS. <p>NOTE For different OSs, you may need to shut down the OS as prompted.</p> <ul style="list-style-type: none"> When the device is powered on, you can hold down this button for 6 seconds to forcibly power off the device. When the power indicator is steady yellow, you can press this button to power on the device.

Sign	Indicators and Buttons	Description
	UID button/ indicator	The UID button/indicator helps identify and locate a device. UID indicator: <ul style="list-style-type: none"> • Off: The device is not being located. • Blinking or steady blue: The device is being located. UID button: <ul style="list-style-type: none"> • You can control the UID indicator status by pressing the UID button or using the iBMC. • You can press this button to turn on or off the UID indicator. • You can press and hold down this button for 4 to 6 seconds to reset the iBMC.
	Health status indicator	<ul style="list-style-type: none"> • Off: The device is powered off or faulty. • Blinking red at 1 Hz: A major alarm has been generated on the system. • Blinking red at 5 Hz: A critical alarm has been generated on the system. • Steady green: The device is operating properly.
	FlexIO card presence indicator	<ul style="list-style-type: none"> • Off: The FlexIO card is not detected. • Blinking green at 0.5 Hz: The FlexIO card is detected but is not powered on. • Blinking green at 2 Hz: The FlexIO card is detected and has just been inserted. • Steady green: The FlexIO card is detected and the power supply is normal.
	iBMC direct connect management port indicator	Indicates the status when the iBMC direct connect management port connects to a terminal (local PC): <ul style="list-style-type: none"> • Off: No terminal is connected. • Blinking green at short intervals for 3 seconds and then off: The port is disabled. • Steady green: The terminal is connected.

5.1.3 Ports

Port Positions

- 8 x 2.5" drive pass-through configuration (8 x SAS/SATA)

Figure 5-15 Ports on the front panel

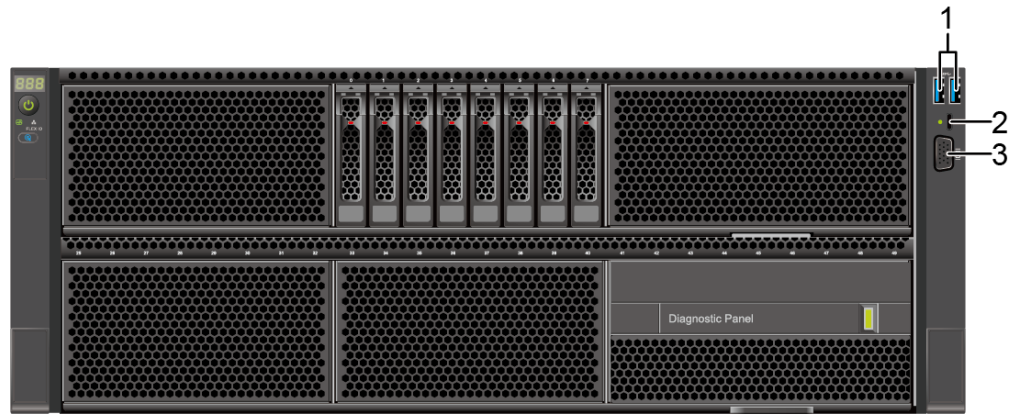

1	USB 3.0 port	2	iBMC direct connect management port
3	VGA port	-	-

- 12 x 2.5" drive pass-through configuration (4 x SAS/SATA + 8 x NVMe)

Figure 5-16 Ports on the front panel

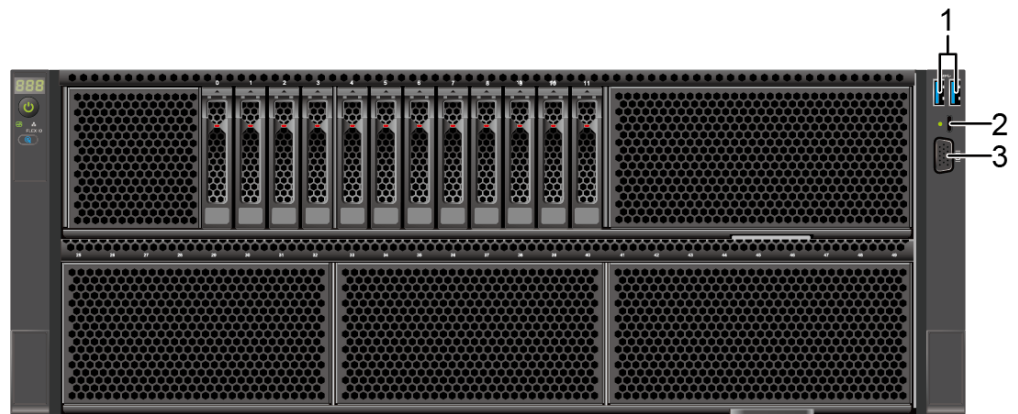

1	USB 3.0 port	2	iBMC direct connect management port
3	VGA port	-	-

- 24 x 2.5" drive pass-through configuration (24 x SAS/SATA)

Figure 5-17 Ports on the front panel

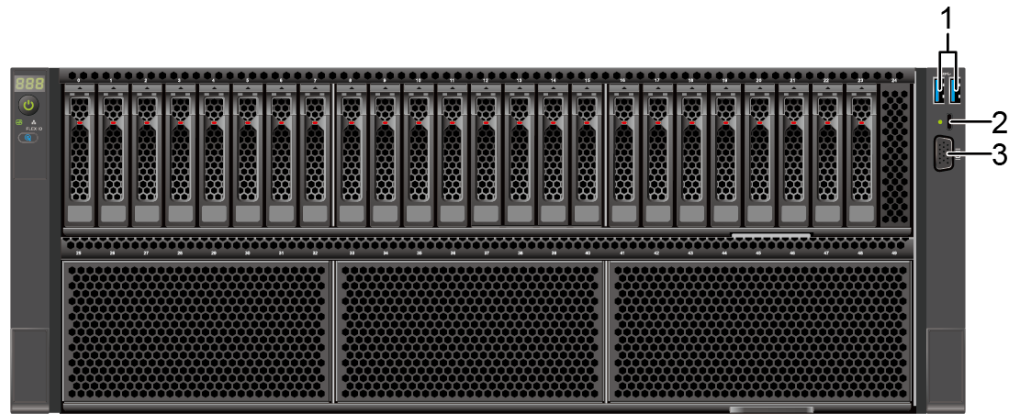

1	USB 3.0 port	2	iBMC direct connect management port
3	VGA port	-	-

- 24 x 2.5" drive pass-through configuration (24 x NVMe)

Figure 5-18 Ports on the front panel



1	USB 3.0 port	2	iBMC direct connect management port
3	VGA port	-	-

- 25 x 2.5" drive EXP configuration (25 x SAS/SATA)

Figure 5-19 Ports on the front panel

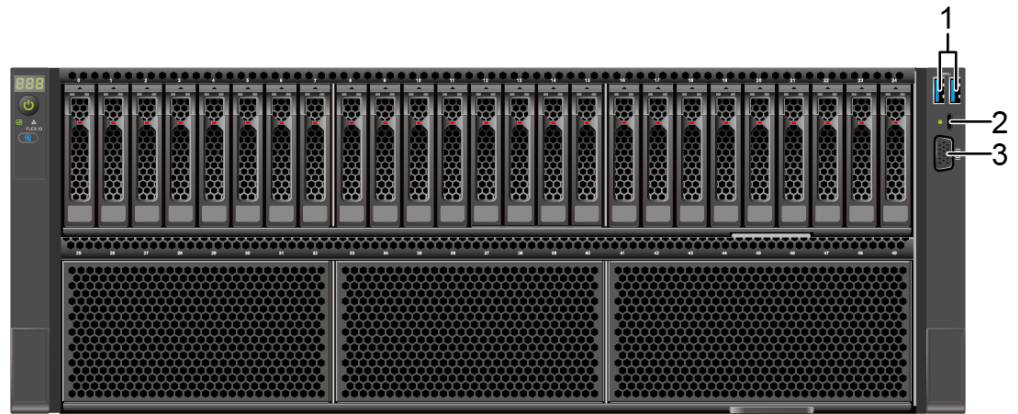

1	USB 3.0 port	2	iBMC direct connect management port
3	VGA port	-	-

- 50 x 2.5" drive configuration (50 x SAS/SATA)

Figure 5-20 Ports on the front panel



1	USB 3.0 port	2	iBMC direct connect management port
3	VGA port	-	-

- 49 x 2.5" drive configuration (25 x SAS/SATA + 24 x NVMe)

Figure 5-21 Ports on the front panel

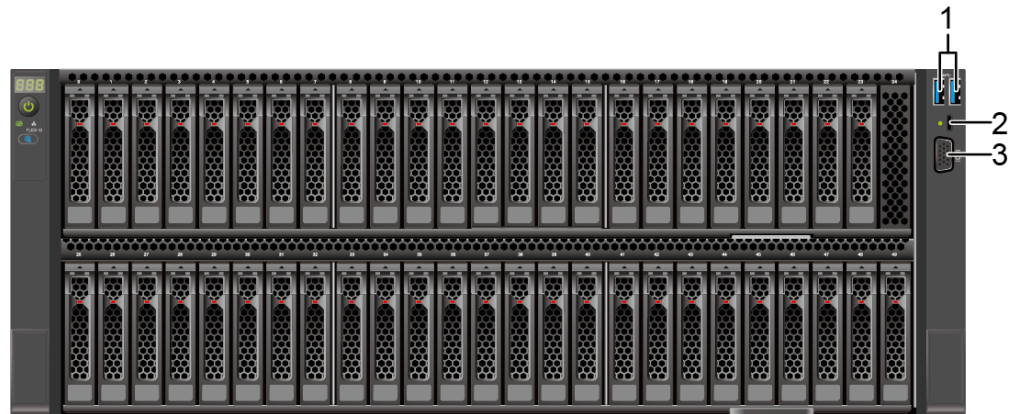

1	USB 3.0 port	2	iBMC direct connect management port
3	VGA port	-	-

Port Description

Table 5-2 Ports on the front panel

Tool	Type	Quantity ^{Note}	Description
VGA port	DB15	1	Used to connect a display terminal, such as a monitor or KVM.
iBMC direct connect management port	USB Type-C NOTE The USB 2.0 protocol is supported.	1	Used to connect to a local PC using a USB Type-C cable to monitor and manage the system. NOTE Only local PCs running Windows 10 are supported. <ul style="list-style-type: none"> To log in to the iBMC from a local PC, enter https://IP address of the iBMC management network port in the address box of the browser on the local PC.

Tool	Type	Quantity <small>Note</small>	Description
USB port	USB 3.0	2	Used to connect to a USB 3.0 device. NOTE <ul style="list-style-type: none"> Before connecting an external USB device, ensure that the USB device functions properly; otherwise, it may adversely impact the server. The USB 3.0 port can be used to supply power to low-power peripherals. However, the USB 3.0 port must comply with the USB specifications. To run advanced peripherals, such as external CD/DVD drives, an external power supply is required.

5.2 Rear Panel

5.2.1 Appearance

- Server with a drive module or PCIe riser module on the rear panel

Figure 5-22 Rear view

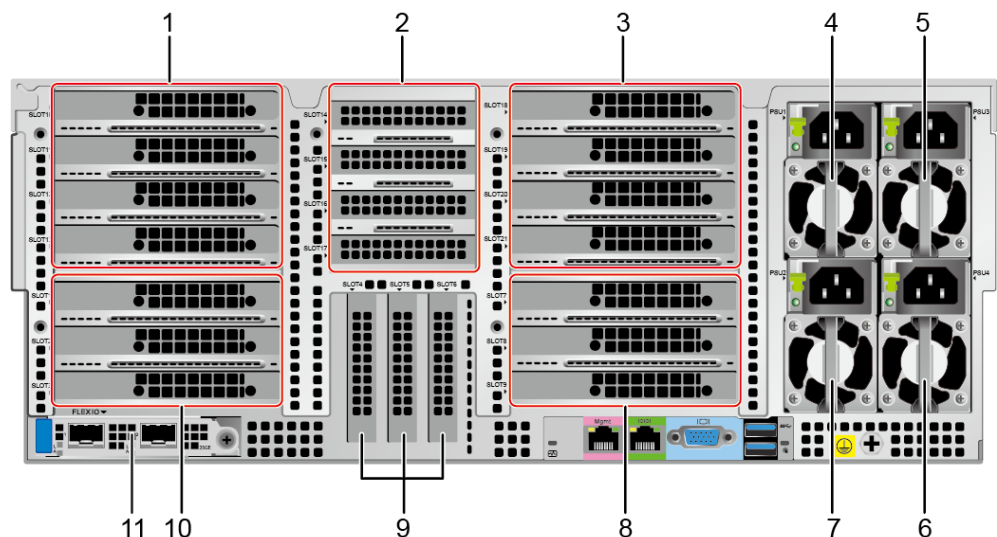

1	I/O module 3	2	I/O module 4
3	I/O module 5	4	PSU 1

5	PSU 3	6	PSU 4
7	PSU 2	8	I/O module 2
9	PCIe slot	10	I/O module 1
11	(Optional) FlexIO card NOTE The FlexIO card slot supports only an OCP 3.0 NIC.	-	-

NOTE

- I/O module 4 supports a PCIe riser module or 2 x 2.5" rear-drive module.
- For details about the OCP 3.0 NIC, see [5.6.1 OCP 3.0 NICs](#).
- The figure is for reference only. The actual configuration may vary.
- Server with four GPUs on the rear panel

Figure 5-23 Rear view

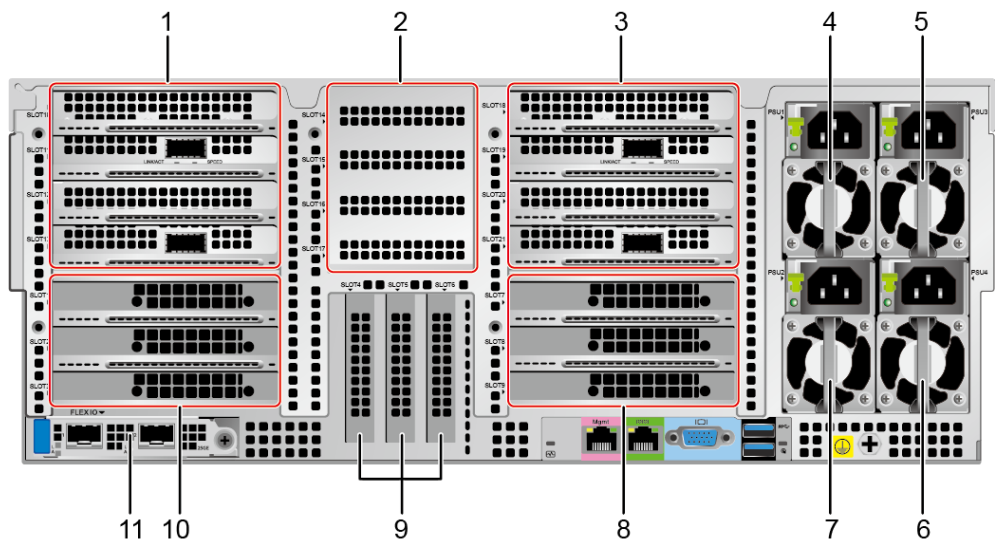

1	I/O module 3	2	Filler panel
3	I/O module 5	4	PSU 1
5	PSU 3	6	PSU 4
7	PSU 2	8	I/O module 2
9	PCIe slot	10	I/O module 1

11	(Optional) FlexIO card NOTE The FlexIO card slot supports only OCP 3.0 NICs.	-	-
----	---	---	---

5.2.2 Indicator

Indicator Positions

- Server with a drive module or PCIe riser module on the rear panel

Figure 5-24 Indicators on the rear panel

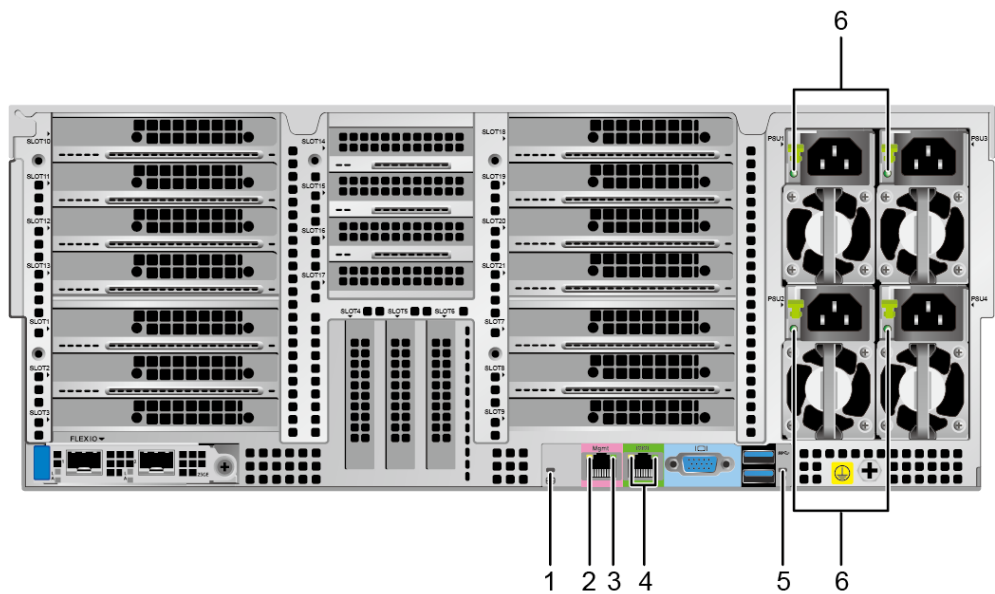

1	Health status indicator	2	Data transmission status indicator of the management network port
3	Connection status indicator of the management network port	4	Serial port indicator NOTE Reserved and unavailable currently.
5	UID indicator	6	PSU indicator

- Server with four GPU cards on the rear panel

Figure 5-25 Indicators on the rear panel

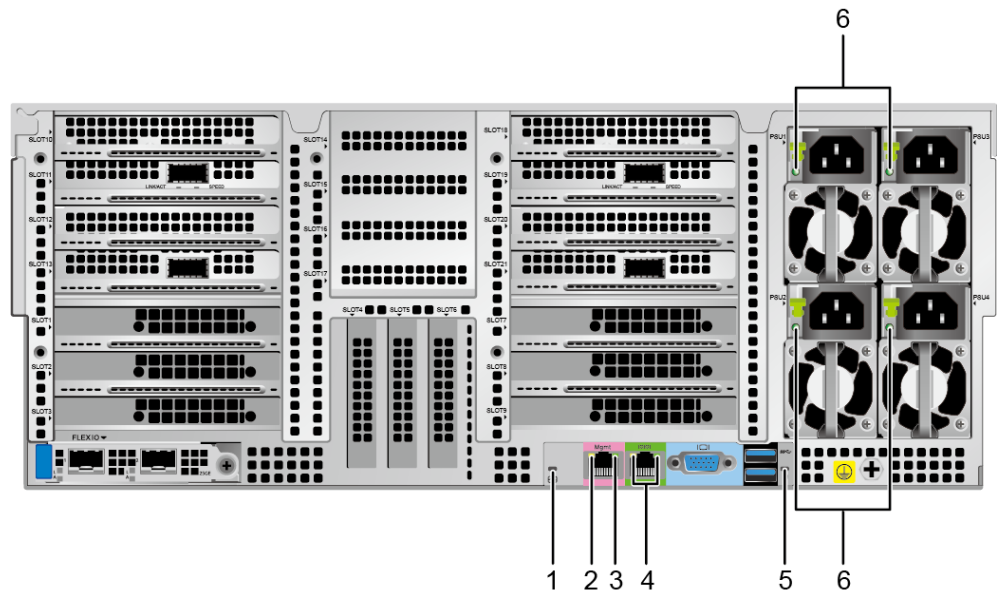

1	Health status indicator	2	Data transmission status indicator of the management network port
3	Connection status indicator of the management network port	4	Serial port indicator NOTE Reserved and unavailable currently.
5	UID indicator	6	PSU indicator

Indicator Description

Table 5-3 Description of indicators on the rear panel

Sign	Indicator	Description
-	Data transmission status indicator of the management network port	<ul style="list-style-type: none"> Off: No data is being transmitted. Blinking yellow: Data is being transmitted.
-	Connection status indicator of the management network port	<ul style="list-style-type: none"> Off: The network is not connected. Steady green: The network port is properly connected.

Sign	Indicator	Description
-	PSU indicator	<ul style="list-style-type: none"> ● Off: No power is supplied. ● Blinking green at 1 Hz: <ul style="list-style-type: none"> – The input is normal and the power supply enters SV12 mode. – The input is overvoltage or undervoltage. – The PSU is in deep hibernation mode. ● Blinking green at 4 Hz: The firmware is being upgraded online. ● Steady green: The input and output are normal. ● Steady orange: The input is normal but there is no output. <p>NOTE The possible causes of no output are as follows:</p> <ul style="list-style-type: none"> ● Power supply overtemperature protection ● Power output overcurrent or short-circuit ● Output overvoltage ● Short-circuit protection ● Device failure (excluding failure of all devices)
	UID indicator	<p>The UID indicator helps identify and locate a device.</p> <ul style="list-style-type: none"> ● Off: The device is not being located. ● Blinking or steady blue: The device is being located. <p>NOTE You can control the UID indicator status by pressing the UID button or using the iBMC.</p>

5.2.3 Ports

Port Positions

- Server with a drive module or PCIe riser module on the rear panel

Figure 5-26 Ports on the rear panel

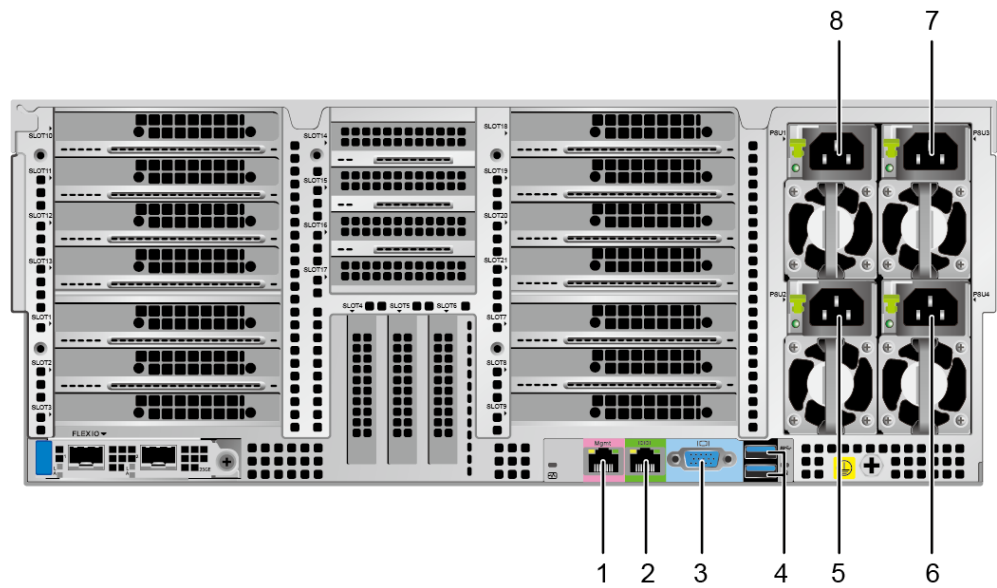

1	Management network port	2	Serial port
3	VGA port	4	USB 3.0 port
5	Socket for PSU 2	6	Socket for PSU 4
7	Socket for PSU 3	8	Socket for PSU 1

- Server with four GPUs on the rear panel

Figure 5-27 Ports on the rear panel

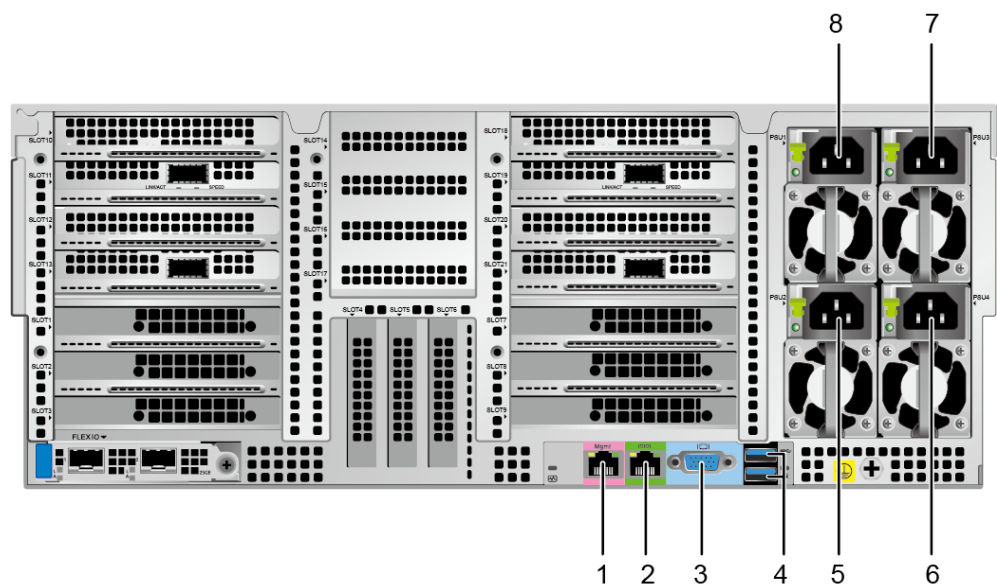

1	Management network port	2	Serial port
3	VGA port	4	USB 3.0 port
5	Socket for PSU 2	6	Socket for PSU 4
7	Socket for PSU 3	8	Socket for PSU 1

Port Description

Table 5-4 Ports on the rear panel

Tool	Type	Quantity	Description
Management network port	RJ45	1	iBMC management network port, which is used to manage the server. NOTE The management network port is a GE port that supports 100 Mbit/s and 1000 Mbit/s auto-negotiation.
Serial port	RJ45	1	A port used for debugging. By default, it serves as the OS serial port. You can also set it as the iBMC serial port on the iBMC CLI. NOTE The port is a 3-wire serial communication port, and its default baud rate is 115,200 bit/s.
VGA port	DB15	1	Used to connect a display terminal, such as a monitor or KVM.
USB 3.0 port	USB 3.0	2	Used to connect to a USB 3.0 device. NOTE <ul style="list-style-type: none"> • Before connecting an external USB device, ensure that the USB device functions properly; otherwise, it may adversely impact the server. • The USB 3.0 port can be used to supply power to low-power peripherals. However, the USB 3.0 port must comply with the USB specifications. To run advanced peripherals, such as external CD/DVD drives, an external power supply is required.

Tool	Type	Quantity	Description
PSU socket	-	4	Used to connect to a power distribution unit (PDU) through a power cable. You can select the PSUs as required. NOTE When determining the PSUs, ensure that the rated power of the PSUs is greater than that of the server.

5.3 Processors

- The server supports two or four processors.
- If two processors are required, install them in sockets CPU 1 and CPU 2.
- Processors of the same model must be used in a server.
- For details about the optional components, consult the local sales representative or see "Search Parts" in the compatibility list on the technical support website.

Figure 5-28 Positions of the processors

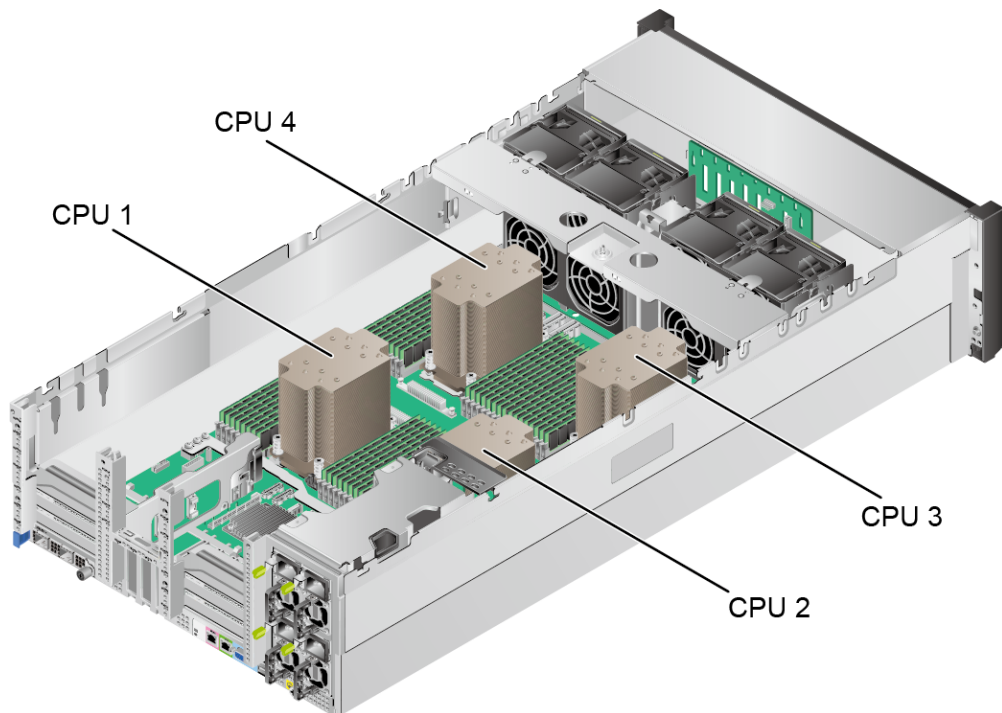

5.4 Memory

5.4.1 DDR5 Memory

5.4.1.1 Memory Identifier

You can determine the memory module properties based on the label attached to the memory module.

Figure 5-29 Memory identifier

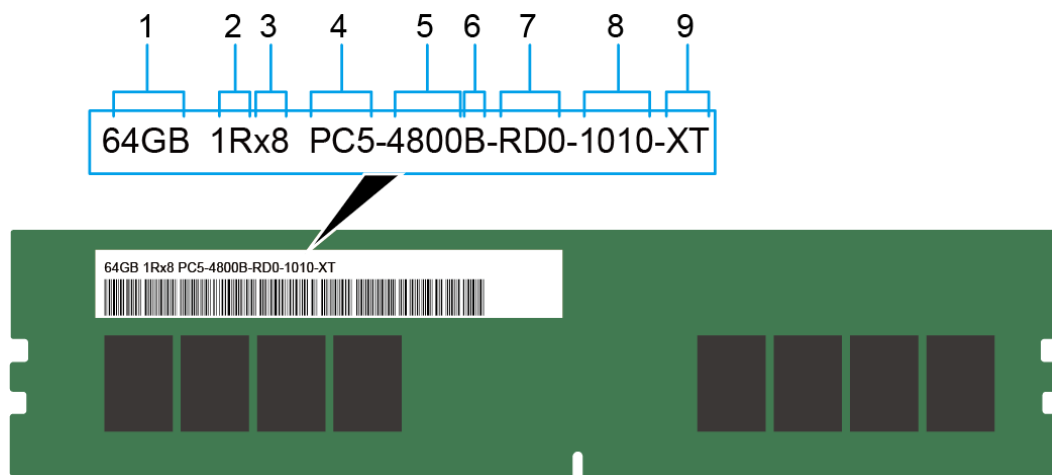

No.	Description	Example
1	Capacity	<ul style="list-style-type: none"> • 16 GB • 32 GB • 64 GB • 128 GB • 256 GB
2	rank(s)	<ul style="list-style-type: none"> • 1R = Single rank • 2R = Dual rank • 4R = Quad rank • 8R = Octal rank
3	Data width on the DRAM	<ul style="list-style-type: none"> • x4: 4-bit • x8: 8-bit
4	Type of the memory interface	<ul style="list-style-type: none"> • PC5 = DDR5
5	Maximum memory speed	<ul style="list-style-type: none"> • 4800 MT/s
6	Memory Delay Parameter (CL-nRCD-nRP)	<ul style="list-style-type: none"> • A = 34-34-34 • B = 40-40-40 • C = 42-42-42
7	DIMM type	<ul style="list-style-type: none"> • Reference design for version RDIMM D0

No.	Description	Example
8	SPD version	<ul style="list-style-type: none"> 10: SPD version 10: SPD versions from Byte 192 to Byte 447
9	Temperature class	<ul style="list-style-type: none"> Extended temperature grade (XT): 0°C to 95°C (32°F to 203°F) Normal temperature grade (NT): 0°C to 85°C (32°F to 185°F)

5.4.1.2 Memory Subsystem Architecture

The server provides 64 memory slots. Each processor integrates eight memory channels.

Install the memory modules in the primary memory channels first. If the primary memory channel is not populated, the memory modules in secondary memory channels cannot be used.

Table 5-5 Memory channels

CPU	Channel	Memory Slot
CPU 1	A (primary)	DIMM000(A)
	A	DIMM001(I)
	B (primary)	DIMM010(B)
	B	DIMM011(J)
	C (primary)	DIMM020(C)
	C	DIMM021(K)
	D (primary)	DIMM030(D)
	D	DIMM031(L)
	E (primary)	DIMM040(E)
	E	DIMM041(M)
	F (primary)	DIMM050(F)
	F	DIMM051(N)
	G (primary)	DIMM060(G)
	G	DIMM061(O)
	H (primary)	DIMM070(H)

CPU	Channel	Memory Slot
	H	DIMM071(P)
CPU2	A (primary)	DIMM100(A)
	A	DIMM101(I)
	B (primary)	DIMM110(B)
	B	DIMM111(J)
	C (primary)	DIMM120(C)
	C	DIMM121(K)
	D (primary)	DIMM130(D)
	D	DIMM131(L)
	E (primary)	DIMM140(E)
	E	DIMM141(M)
	F (primary)	DIMM150(F)
	F	DIMM151(N)
	G (primary)	DIMM160(G)
	G	DIMM161(O)
CPU3	H (primary)	DIMM170(H)
	H	DIMM171(P)
	A (primary)	DIMM200(A)
	A	DIMM201(I)
	B (primary)	DIMM210(B)
	B	DIMM211(J)
	C (primary)	DIMM220(C)
	C	DIMM221(K)
	D (primary)	DIMM230(D)
	D	DIMM231(L)
	E (primary)	DIMM240(E)
	E	DIMM241(M)
	F (primary)	DIMM250(F)
	F	DIMM251(N)
G (primary)	DIMM260(G)	

CPU	Channel	Memory Slot
	G	DIMM261(O)
	H (primary)	DIMM270(H)
	H	DIMM271(P)
CPU4	A (primary)	DIMM300(A)
	A	DIMM301(I)
	B (primary)	DIMM310(B)
	B	DIMM311(J)
	C (primary)	DIMM320(C)
	C	DIMM321(K)
	D (primary)	DIMM330(D)
	D	DIMM331(L)
	E (primary)	DIMM340(E)
	E	DIMM341(M)
	F (primary)	DIMM350(F)
	F	DIMM351(N)
	G (primary)	DIMM360(G)
	G	DIMM361(O)
	H (primary)	DIMM370(H)
H	DIMM371(P)	

5.4.1.3 Memory Compatibility

Observe the following rules when configuring DDR5 memory modules:

NOTICE

- A server must use DDR5 memory modules of the same part number (P/N code), and the memory speed is the lower one of the following two speed values:
 - Memory speed supported by a CPU
 - Maximum operating speed of a memory module
- The DDR5 memory modules of different types (RDIMM and RDIMM-3DS) and specifications (capacity, bit width, rank, and height) cannot be used together.
- For details about the optional components, consult the local sales representative or see "Search Parts" in the compatibility list on the technical support website.

- The memory module can be used with the new-generation Intel® Xeon® Scalable processors (Sapphire Rapids). The maximum memory capacity supported by all processor models is the same.
- The calculation formula of total memory capacity supported is as follows: the total memory capacity equals the capacity sum of all DDR5 memory modules.
- For details about the type of a single memory module, consult your local sales representatives or see "Search Parts" in the compatibility list on the technical support website.
- The maximum number of memory modules supported depends on the CPU type, memory module type, and number of ranks.

 **NOTE**

Each RDIMM channel supports a maximum of 4 ranks and each LRDIMM channel supports a maximum of 8 ranks. The number of memory modules supported by each channel varies depending on the number of ranks supported by each channel:

Number of memory modules supported by each channel ≤ Number of ranks supported by each memory channel/Number of ranks supported by each memory module

Table 5-6 DDR5 memory parameters

Parameter		Specifications				
Capacity of a DDR5 memory (GB)		16	32	64	128	256
Type		RDIMM	RDIMM	RDIMM	RDIMM-3 DS	RDIMM-3 DS
Rated speed (MT/s)		4800	4800	4800	4800	4800
Operating voltage (V)		1.1	1.1	1.1	1.1	1.1
Maximum number of DDR5 DIMMs of a server ^a		64	64	64	64	64
Maximum DDR5 memory capacity of the server (GB)		512	2048	4096	8192	16384
Actual rate (MT/s)	1DPC ^b	4800	4800	4800	4800	4800
	2DPC	4400	4400	4400	4400	4400
<ul style="list-style-type: none"> • a: The maximum number of DDR5 memory modules is based on 4-processor configuration. The number is halved for a server with two processors. • b: DIMM per channel (DPC) indicates the number of memory modules per channel. • The information listed in this table is for reference only. For details, consult the local sales representatives or see "Search Parts" in the compatibility list on the technical support website. 						

5.4.1.4 Memory Module Installation Rules

Observe the following rules when configuring DDR5 memory modules:

- At least one DDR5 memory module must be configured if the server uses SPR CPUs (excluding HBM CPUs).
- The memory modules configured must be DDR5 RDIMMs.
- The memory modules must be configured with the same number of ranks.
- Install filler memory modules in vacant slots.

5.4.1.5 Positions of the memory modules

The server supports up to 64 DDR5 memory modules. To maximize memory performance, you are advised to use balanced memory configuration.

Observe the memory module installation rules when configuring memory modules. For details, see the memory configuration guide on the technical support website.

Figure 5-30 Positions of the memory modules

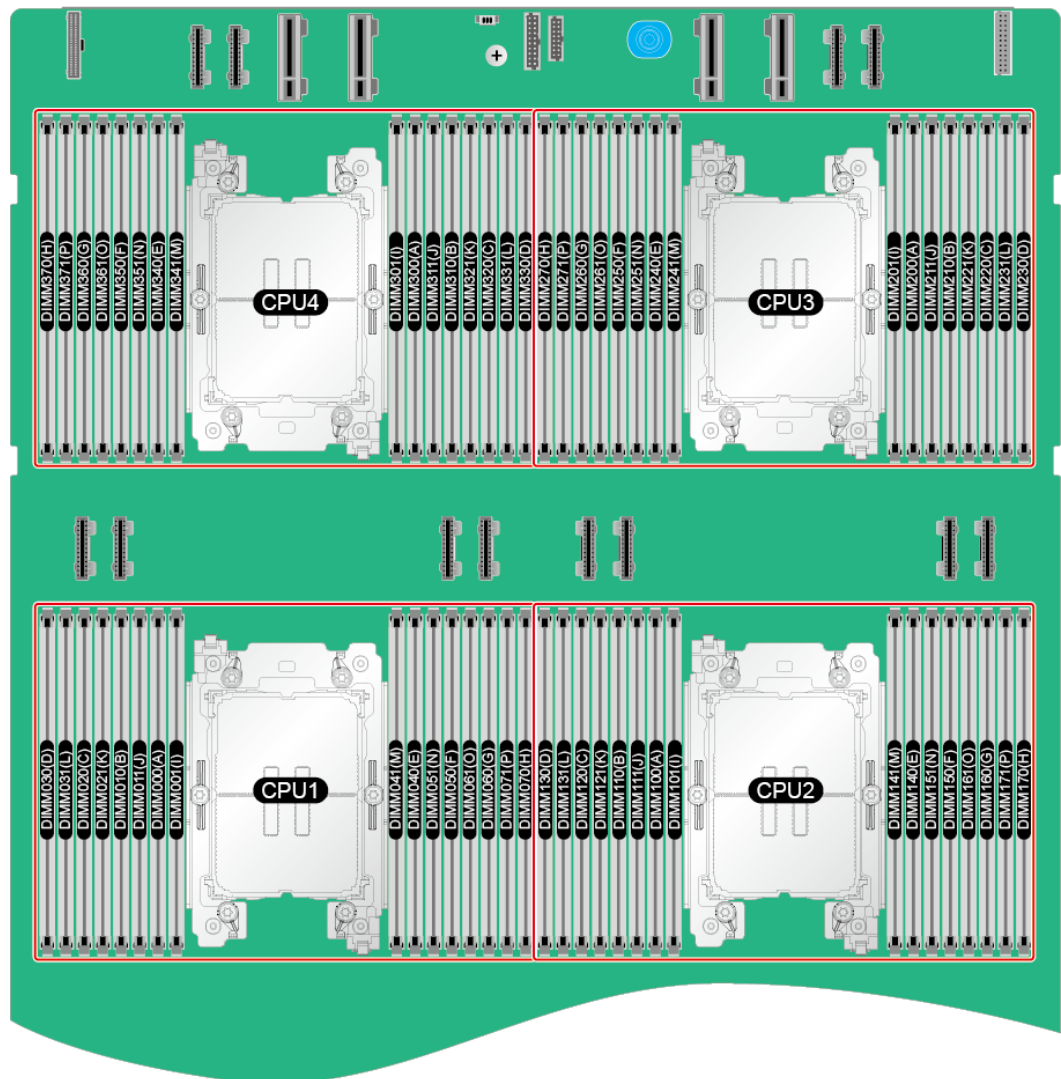

Figure 5-31 Recommended slots for DDR5 memory modules (2 processors)

CPU	Channel	DIMM Slot	Number of DIMMs						
			2	4	8	12	16	24	32
CPU1	A	DIMM000 (A)	*	*	*	*	*	*	*
		DIMM001 (I)						*	*
	B	DIMM010 (B)					*	*	*
		DIMM011 (J)							*
	C	DIMM020 (C)			*	*	*	*	*
		DIMM021 (K)						*	*
	D	DIMM030 (D)				*	*	*	*
		DIMM031 (L)							*
	E	DIMM040 (E)			*	*	*	*	*
		DIMM041 (M)						*	*
	F	DIMM050 (F)				*	*	*	*
		DIMM051 (N)							*
	G	DIMM060 (G)		*	*	*	*	*	*
		DIMM061 (O)						*	*
	H	DIMM070 (H)					*	*	*
		DIMM071 (P)							*
CPU2	A	DIMM000 (A)	*	*	*	*	*	*	*
		DIMM001 (I)						*	*
	B	DIMM010 (B)					*	*	*
		DIMM011 (J)							*
	C	DIMM020 (C)			*	*	*	*	*
		DIMM021 (K)						*	*
	D	DIMM030 (D)				*	*	*	*
		DIMM031 (L)							*
	E	DIMM040 (E)			*	*	*	*	*
		DIMM041 (M)						*	*
	F	DIMM050 (F)				*	*	*	*
		DIMM051 (N)							*
	G	DIMM060 (G)		*	*	*	*	*	*
		DIMM061 (O)						*	*
	H	DIMM070 (H)					*	*	*
		DIMM071 (P)							*

Figure 5-32 Recommended slots for DDR5 memory modules (4 processors)

CPU	Channel	DIMM Slot	Number of DIMMs						
			4	8	16	24	32	48	64
CPU1	A	DIMM000(A)	*	*	*	*	*	*	*
		DIMM001(I)						*	*
	B	DIMM010(B)					*	*	*
		DIMM011(J)							*
	C	DIMM020(C)			*	*	*	*	*
		DIMM021(K)						*	*
	D	DIMM030(D)				*	*	*	*
		DIMM031(L)							*
	E	DIMM040(E)			*	*	*	*	*
		DIMM041(M)						*	*
	F	DIMM050(F)				*	*	*	*
		DIMM051(N)							*
	G	DIMM060(G)		*	*	*	*	*	*
		DIMM061(O)						*	*
	H	DIMM070(H)					*	*	*
		DIMM071(P)							*
CPU2	A	DIMM100(A)	*	*	*	*	*	*	*
		DIMM101(I)						*	*
	B	DIMM110(B)					*	*	*
		DIMM111(J)							*
	C	DIMM120(C)			*	*	*	*	*
		DIMM121(K)						*	*
	D	DIMM130(D)				*	*	*	*
		DIMM131(L)							*
	E	DIMM140(E)			*	*	*	*	*
		DIMM141(M)						*	*
	F	DIMM150(F)				*	*	*	*
		DIMM151(N)							*
	G	DIMM160(G)		*	*	*	*	*	*
		DIMM161(O)						*	*
	H	DIMM170(H)					*	*	*
		DIMM171(P)							*
CPU3	A	DIMM200(A)	*	*	*	*	*	*	*
		DIMM201(I)						*	*
	B	DIMM210(B)					*	*	*
		DIMM211(J)							*
	C	DIMM220(C)			*	*	*	*	*
		DIMM221(K)						*	*
	D	DIMM230(D)				*	*	*	*
		DIMM231(L)							*
	E	DIMM240(E)			*	*	*	*	*
		DIMM241(M)						*	*
	F	DIMM250(F)				*	*	*	*
		DIMM251(N)							*
	G	DIMM260(G)		*	*	*	*	*	*
		DIMM261(O)						*	*
	H	DIMM270(H)					*	*	*
		DIMM271(P)							*
CPU4	A	DIMM300(A)	*	*	*	*	*	*	*
		DIMM301(I)						*	*
	B	DIMM310(B)					*	*	*
		DIMM311(J)							*
	C	DIMM320(C)			*	*	*	*	*
		DIMM321(K)						*	*
	D	DIMM330(D)				*	*	*	*
		DIMM331(L)							*
	E	DIMM340(E)			*	*	*	*	*
		DIMM341(M)						*	*
	F	DIMM350(F)				*	*	*	*
		DIMM351(N)							*
	G	DIMM360(G)		*	*	*	*	*	*
		DIMM361(O)						*	*
	H	DIMM370(H)					*	*	*
		DIMM371(P)							*

5.4.1.6 Memory Protection Technologies

DDR5 memory modules support the following memory protection technologies:

- ECC
- Memory Mirroring
- Memory Single Device Data Correction (SDDC)
- Failed DIMM Isolation
- Memory Thermal Throttling
- Command/Address Parity Check and Retry
- Memory Demand/Patrol Scrubbing
- Memory Data Scrambling
- Post Package Repair (PPR)
- Write Data CRC Protection
- Adaptive Data Correction - Single Region (ADC-SR)
- Adaptive Double Device Data Correction - Multiple Region (ADDDC-MR)
- Partial Cache Line Spraying (PCLS, HBM only)

5.5 Storage

5.5.1 Drive Configuration and Drive Numbering

5.5.1.1 8 x 2.5" Drive Pass-Through Configuration

Drive Configuration

Table 5-7 Drive configuration

Configuration	Front Drive	Rear Drive	Built-in Drive	Drive Management Mode
8 x 2.5" drive pass-through configuration 1 ^a	<ul style="list-style-type: none"> • Front drive (8 x 2.5"): <ul style="list-style-type: none"> – Slots 0 to 7 support only SATA drives. 	-	-	<ul style="list-style-type: none"> • PCH pass-through

Configuration	Front Drive	Rear Drive	Built-in Drive	Drive Management Mode
8 x 2.5" drive pass-through configuration 2 ^a	<ul style="list-style-type: none"> Front drive (8 x 2.5"): <ul style="list-style-type: none"> Slots 0 to 7 support SAS/SATA drives. 	-	-	<ul style="list-style-type: none"> 1 x PCIe plug-in RAID controller card^b
8 x 2.5" drive + 4 x GPU card configuration 1 ^c	<ul style="list-style-type: none"> Front drive (8 x 2.5"): <ul style="list-style-type: none"> Slots 0 to 7 support only SATA drives. 	-	-	<ul style="list-style-type: none"> PCH pass-through
8 x 2.5" drive + 4 x GPU card configuration 2 ^c	<ul style="list-style-type: none"> Front drive (8 x 2.5"): <ul style="list-style-type: none"> Slots 0 to 7 support SAS/SATA drives. 	-	-	<ul style="list-style-type: none"> 1 x PCIe plug-in RAID controller card^b
<ul style="list-style-type: none"> a: The current configuration supports six 8080 fans or eight 8038 fans. The quantity of fans vary with actual configuration. b: The PCIe plug-in RAID controller card is installed in slot 4 by default. c: The current configuration supports only six 8080 fans. For details about the optional components, consult the local sales representative or see "Search Parts" in the compatibility list on the technical support website. 				

Drive Numbering

NOTICE

The drive numbers identified by the RAID controller card vary depending on the cabling of the RAID controller card. This section uses the drive numbers identified by a RAID controller card that adopts the default cabling described in "Internal Cabling" in the server *Maintenance and Service Guide*.

- Drive numbering of the 8 x 2.5" drive pass-through configuration 1 in [Table 5-7](#).

Figure 5-33 Drive Numbering

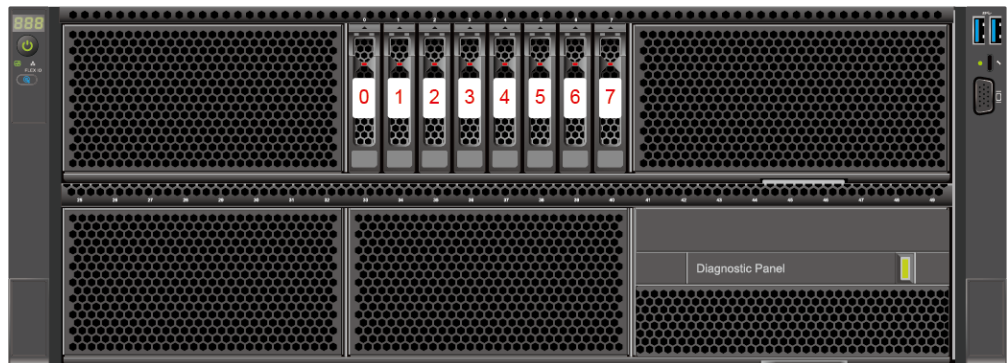

Table 5-8 Drive numbering

Drive No.	Drive Number Displayed on the iBMC WebUI
0	0
1	1
2	2
3	3
4	4
5	5
6	6
7	7

- Drive numbering of the 8 x 2.5" drive pass-through configuration 2 in [Table 5-7](#)

Figure 5-34 Drive Numbering

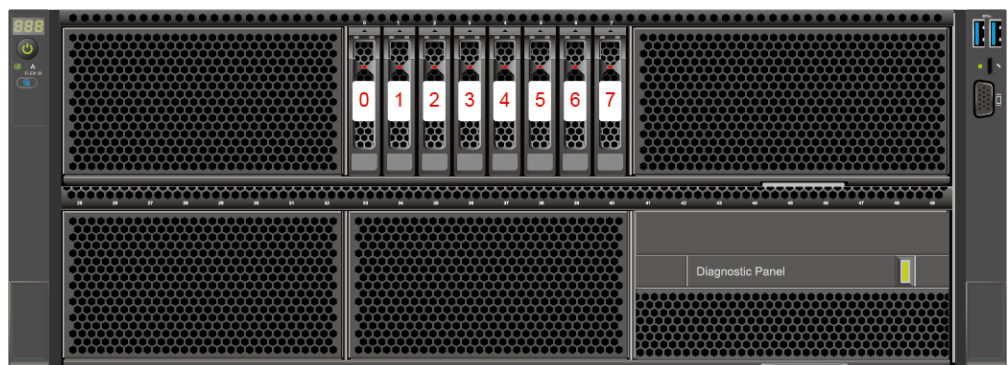

Table 5-9 Drive numbering

Drive No.	Drive Number Displayed on the iBMC WebUI	Drive Number Identified by the RAID Controller Card
0	0	0
1	1	1
2	2	2
3	3	3
4	4	4
5	5	5
6	6	6
7	7	7

- Drive numbering of the configuration 1: 8 x 2.5" drives + 4 x GPU cards in [Table 5-7](#).

Figure 5-35 Drive Numbering

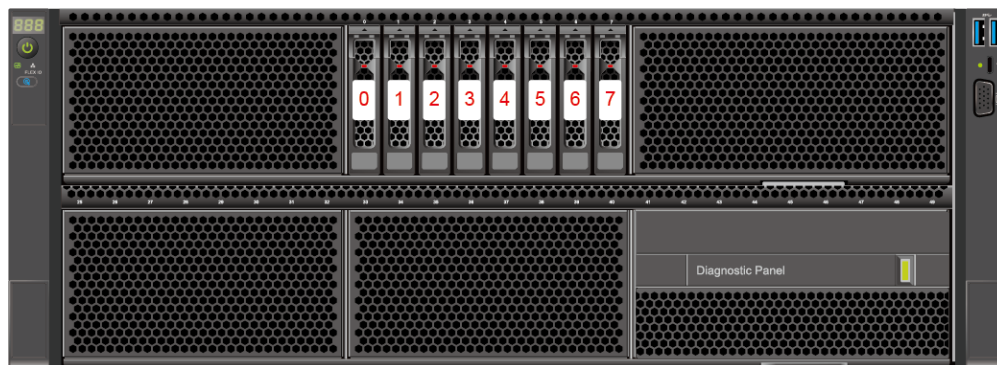

Table 5-10 Drive numbering

Drive No.	Drive Number Displayed on the iBMC WebUI
0	0
1	1
2	2
3	3
4	4
5	5
6	6

Drive No.	Drive Number Displayed on the iBMC WebUI
7	7

- Drive numbering of the 8 x 2.5" drive + 4 x GPU card configuration 2 in [Table 5-7](#)

Figure 5-36 Drive numbering

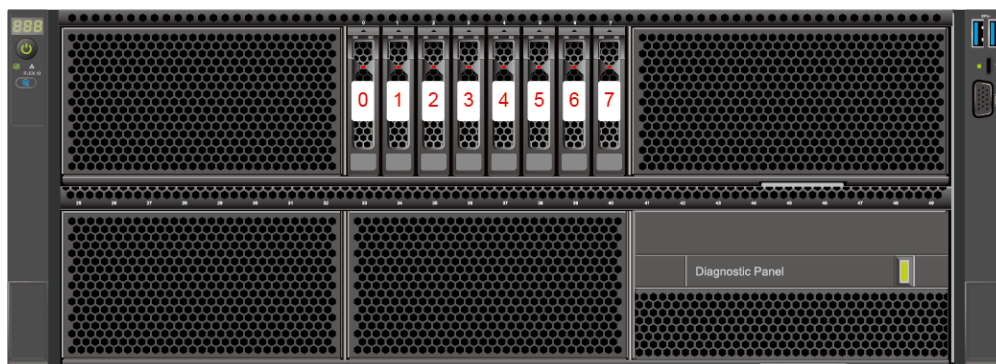

Table 5-11 Drive numbering

Drive No.	Drive Number Displayed on the iBMC WebUI	Drive Number Identified by the RAID Controller Card
0	0	0
1	1	1
2	2	2
3	3	3
4	4	4
5	5	5
6	6	6
7	7	7

5.5.1.2 12 x 2.5" Drive Pass-Through Configuration

Drive Configuration

Table 5-12 Drive configuration

Configuration	Front Drive	Rear Drive	Built-in Drive	Drive Management Mode
12 x 2.5" drive (4 x SATA + 8 x NVMe) pass-through configuration 1 ^a	<ul style="list-style-type: none"> • Front drive: 12 x 2.5" <ul style="list-style-type: none"> – Slots 0 to 3 support only SATA drives. – Slots 4 to 7 support SATA/ NVMe drives. – Slots 8 to 11 support only NVMe drives. 	-	-	<ul style="list-style-type: none"> • SATA drive: PCH pass-through • NVMe drive: CPU pass-through

Configuration	Front Drive	Rear Drive	Built-in Drive	Drive Management Mode
12 x 2.5" drive (4 x SAS/ SATA + 8 x NVMe) pass-through configuration 2 ^a	<ul style="list-style-type: none"> ● Front drive: 12 x 2.5" <ul style="list-style-type: none"> – Slots 0 to 3 support SAS/ SATA drives. – Slots 4 to 7 support SAS/ SATA/ NVMe drives. – Slots 8 to 11 support only NVMe drives. 	-	-	<ul style="list-style-type: none"> ● SAS/SATA drive: 1 x PCIe RAID controller card^b/1 x RAID controller cable card ● NVMe drive: CPU pass-through
12 x 2.5" drive (4 x SATA + 8 x NVMe) + 4 x GPU card configuration 1 ^c	<ul style="list-style-type: none"> ● Front drive: 12 x 2.5" <ul style="list-style-type: none"> – Slots 0 to 3 support only SATA drives. – Slots 4 to 7 support SATA/ NVMe drives. – Slots 8 to 11 support only NVMe drives. 	-	-	<ul style="list-style-type: none"> ● SATA drive: PCH pass-through ● NVMe drive: CPU pass-through

Configuration	Front Drive	Rear Drive	Built-in Drive	Drive Management Mode
12 x 2.5" drive (4 x SAS/SATA + 8 x NVMe) + 4 x GPU card configuration 2 ^c	<ul style="list-style-type: none"> • Front drive: 12 x 2.5" <ul style="list-style-type: none"> – Slots 0 to 3 support SAS/SATA drives. – Slots 4 to 7 support SAS/SATA/NVMe drives. – Slots 8 to 11 support only NVMe drives. 	-	-	<ul style="list-style-type: none"> • SAS/SATA drive: 1 x PCIe plug-in RAID controller card^b • NVMe drive: CPU pass-through
<ul style="list-style-type: none"> • a: The current configuration supports six 8080 fans or eight 8038 fans. The quantity of fans vary with actual configuration. • b: The PCIe plug-in RAID controller card is installed in slot 4 by default. • c: The current configuration supports only six 8080 fans. • For details about the optional components, consult the local sales representative or see "Search Parts" in the compatibility list on the technical support website. 				

Drive Numbering

NOTICE

The drive numbers identified by the RAID controller card vary depending on the cabling of the RAID controller card. This section uses the drive numbers identified by a RAID controller card that adopts the default cabling described in "Internal Cabling" in the server *Maintenance and Service Guide*.

- Drive numbering of the 12 x 2.5" drive pass-through configuration 1 (4 x SATA + 8 x NVMe) in [Table 5-12](#)

Figure 5-37 Drive numbering

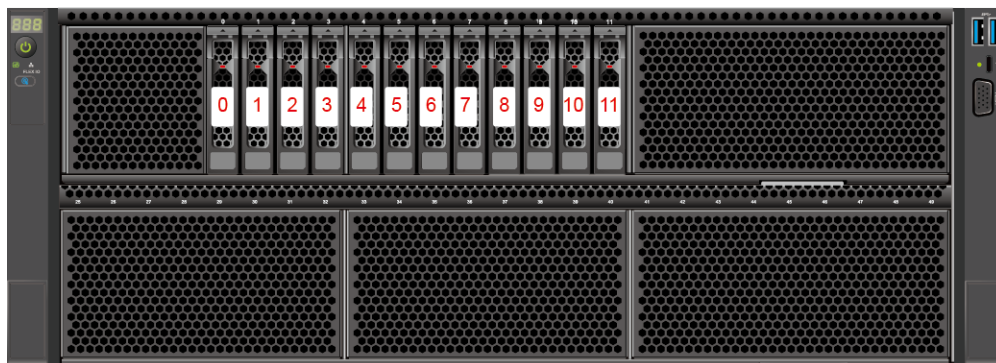

Table 5-13 Drive numbering

Drive No.	Drive Number Displayed on the iBMC WebUI
0	0
1	1
2	2
3	3
4	4
5	5
6	6
7	7
8	8
9	9
10	10
11	11

- Drive numbering of the 12 x 2.5" drive (4 x SAS/SATA + 8 x NVMe) pass-through configuration 2 in [Table 5-12](#)

Figure 5-38 Drive numbering

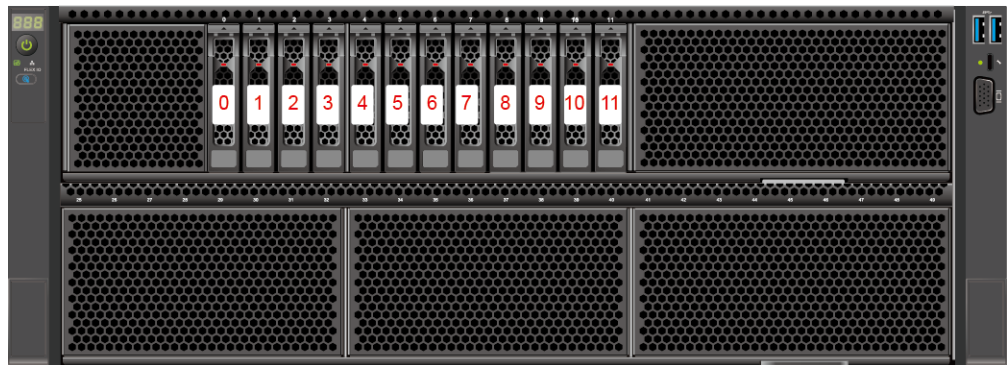

Table 5-14 Drive numbering

Drive No.	Drive Number Displayed on the iBMC WebUI	Drive Number Identified by the RAID Controller Card
0	0	0
1	1	1
2	2	2
3	3	3
4	4	4 ^{Note}
5	5	5 ^{Note}
6	6	6 ^{Note}
7	7	7 ^{Note}
8	8	-
9	9	-
10	10	-
11	11	-

Note: If the slot is configured with a SAS/SATA drive, the RAID controller card can manage the drive and allocate a number to the drive.

- Drive numbering of the 12 x 2.5" drive (4 x SATA + 8 x NVMe) + 4 x GPU card configuration 1 in [Table 5-12](#)

Figure 5-39 Drive numbering



Table 5-15 Drive numbering

Drive No.	Drive Number Displayed on the iBMC WebUI
0	0
1	1
2	2
3	3
4	4
5	5
6	6
7	7
8	8
9	9
10	10
11	11

- Drive numbering of the 12 x 2.5" drive (4 x SAS/SATA + 8 x NVMe) + 4 x GPU card configuration 2 in [Table 5-12](#)

Figure 5-40 Drive numbering

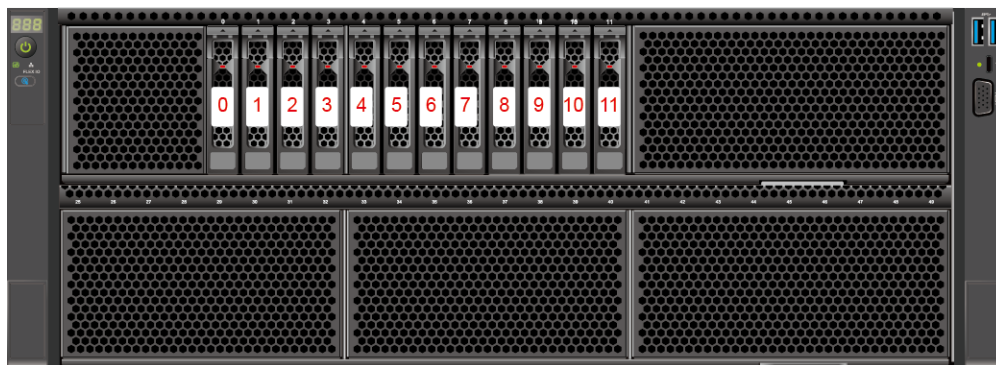

Table 5-16 Drive numbering

Drive No.	Drive Number Displayed on the iBMC WebUI	Drive Number Identified by the RAID Controller Card
0	0	0
1	1	1
2	2	2
3	3	3
4	4	4 ^{Note}
5	5	5 ^{Note}
6	6	6 ^{Note}
7	7	7 ^{Note}
8	8	-
9	9	-
10	10	-
11	11	-

Note: If the slot is configured with a SAS/SATA drive, the RAID controller card can manage the drive and allocate a number to the drive.

5.5.1.3 24 x 2.5" Drive Pass-Through Configuration

Drive Configuration

Table 5-17 Drive configuration

Configuration	Front Drive	Rear Drive	Built-in Drive	Drive Management Mode
24 x 2.5" drive (24 x SAS/SATA) pass-through configuration 1 ^a	<ul style="list-style-type: none"> • Front drive: 24 x 2.5" <ul style="list-style-type: none"> – Slots 0 to 23 support SAS/SATA drives. 	-	-	<ul style="list-style-type: none"> • SAS/SATA drive: 3 x PCIe plug-in RAID controller cards <ul style="list-style-type: none"> – The PCIe plug-in RAID controller card in slot 3 manages drives in slots 0 to 7. – The PCIe plug-in RAID controller card in slot 2 manages drives in slots 8 to 15. – The PCIe plug-in RAID controller card in slot 4 manages drives in slots 16 to 23.

Configuration	Front Drive	Rear Drive	Built-in Drive	Drive Management Mode
24 x 2.5" drive (24 x SAS/SATA) pass-through configuration 2 ^a	<ul style="list-style-type: none"> • Front drive: 24 x 2.5" <ul style="list-style-type: none"> – Slots 0 to 23 support SAS/SATA drives. 	-	-	<ul style="list-style-type: none"> • SAS/SATA drive: 2 x PCIe plug-in RAID controller cards <ul style="list-style-type: none"> – The PCIe plug-in RAID controller card in slot 2 manages drives in slots 0 to 15. – The PCIe plug-in RAID controller card in slot 4 manages drives in slots 16 to 23.
<ul style="list-style-type: none"> • a: The current configuration supports six 8080 fans or eight 8038 fans. The quantity of fans vary with actual configuration. • For details about the optional components, consult the local sales representative or see "Search Parts" in the compatibility list on the technical support website. 				

Drive Numbering

NOTICE

The drive numbers identified by the RAID controller card vary depending on the cabling of the RAID controller card. This section uses the drive numbers identified by a RAID controller card that adopts the default cabling described in "Internal Cabling" in the server *Maintenance and Service Guide*.

- Drive numbering of the 24 x 2.5" drive pass-through configuration 1 in [Table 5-17](#).

Figure 5-41 Drive numbering

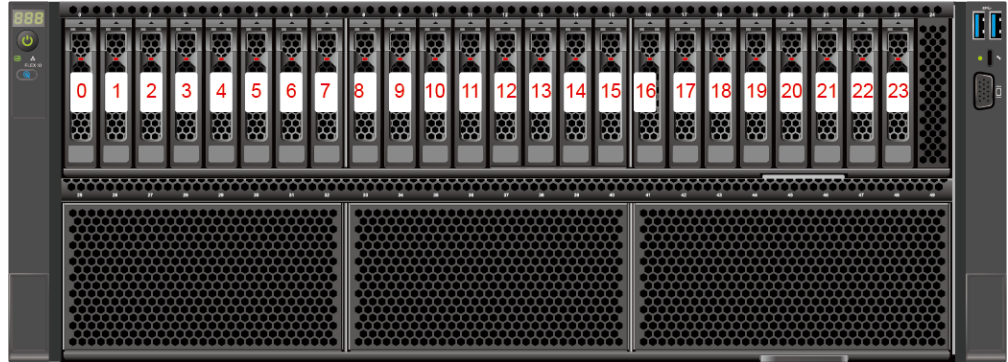

Table 5-18 Drive numbering

Drive No.	Drive Number Displayed on the iBMC WebUI	Drive Number Identified by the RAID Controller Card
0	0	0
1	1	1
2	2	2
3	3	3
4	4	4
5	5	5
6	6	6
7	7	7
8	8	0
9	9	1
10	10	2
11	11	3
12	12	4
13	13	5
14	14	6
15	15	7
16	16	0
17	17	1

Drive No.	Drive Number Displayed on the iBMC WebUI	Drive Number Identified by the RAID Controller Card
18	18	2
19	19	3
20	20	4
21	21	5
22	22	6
23	23	7

- Drive numbering of the 24 x 2.5" drive pass-through configuration 2 in [Table 5-17](#).

Figure 5-42 Drive numbering

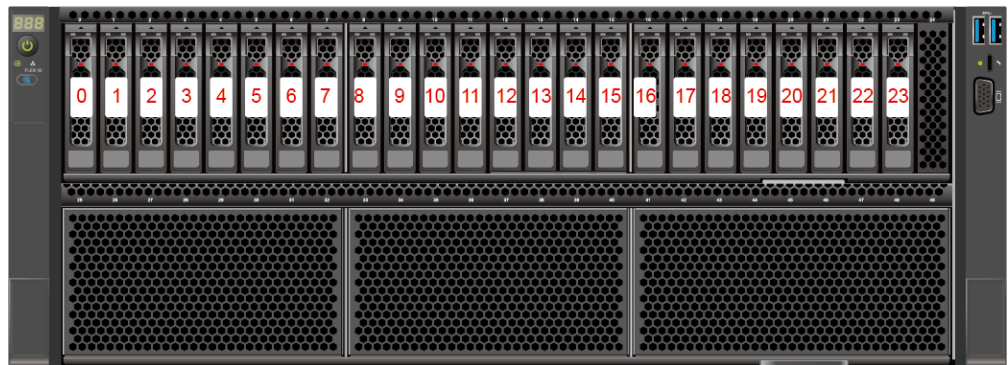

Table 5-19 Drive numbering

Drive No.	Drive Number Displayed on the iBMC WebUI	Drive Number Identified by the RAID Controller Card
0	0	0
1	1	1
2	2	2
3	3	3
4	4	4
5	5	5
6	6	6
7	7	7
8	8	8

Drive No.	Drive Number Displayed on the iBMC WebUI	Drive Number Identified by the RAID Controller Card
9	9	9
10	10	10
11	11	11
12	12	12
13	13	13
14	14	14
15	15	15
16	16	0
17	17	1
18	18	2
19	19	3
20	20	4
21	21	5
22	22	6
23	23	7

5.5.1.4 24 x 2.5" Drive NVMe Configuration

Drive Configuration

Table 5-20 Drive configuration

Configuration	Front Drive	Rear Drive	Built-in Drive	Drive Management Mode
24 x 2.5" drive NVMe configuration 1 (24 x NVMe) ^a	<ul style="list-style-type: none"> ● Front drive: 24 x 2.5" – Slots 0 to 23 support only NVMe drives. 	-	-	<ul style="list-style-type: none"> ● NVMe drive: CPU pass-through

Configuration	Front Drive	Rear Drive	Built-in Drive	Drive Management Mode
24 x 2.5" drive NVMe configuration 2 (8 x SATA/ NVMe + 16 x NVMe) ^a	<ul style="list-style-type: none"> ● Front drive: 24 x 2.5" <ul style="list-style-type: none"> – Slots 0 to 3 support SATA/ NVMe drives. – Slots 4 to 11 support only NVMe drives. – Slots 12 to 15 support SATA/ NVMe drives. – Slots 16 to 23 support only NVMe drives. 	-	-	<ul style="list-style-type: none"> ● SATA drive: PCH pass-through ● NVMe drive: CPU pass-through

Configuration	Front Drive	Rear Drive	Built-in Drive	Drive Management Mode
24 x 2.5" drive NVMe configuration 3 (8 x SAS/SATA/NVMe + 16 x NVMe) ^a	<ul style="list-style-type: none"> ● Front drive: 24 x 2.5" <ul style="list-style-type: none"> – Slots 0 to 3 support SAS/SATA/NVMe drives. – Slots 4 to 11 support only NVMe drives. – Slots 12 to 15 support SAS/SATA/NVMe drives. – Slots 16 to 23 support only NVMe drives. 	-	-	<ul style="list-style-type: none"> ● SAS/SATA drive: 1 x PCIe plug-in RAID controller card^b ● NVMe drive: CPU pass-through
<ul style="list-style-type: none"> ● a: The current configuration supports six 8080 fans or eight 8038 fans. The quantity of fans vary with actual configuration. ● b: The PCIe plug-in RAID controller card is installed in slot 4 by default. ● For details about the optional components, consult the local sales representative or see "Search Parts" in the compatibility list on the technical support website. 				

Drive Numbering

NOTICE

The drive numbers identified by the RAID controller card vary depending on the cabling of the RAID controller card. This section uses the drive numbers identified by a RAID controller card that adopts the default cabling described in "Internal Cabling" in the server *Maintenance and Service Guide*.

- Drive numbering of the 24 x 2.5" drive NVMe configuration 1 in [Table 5-20](#).

Figure 5-43 Drive numbering

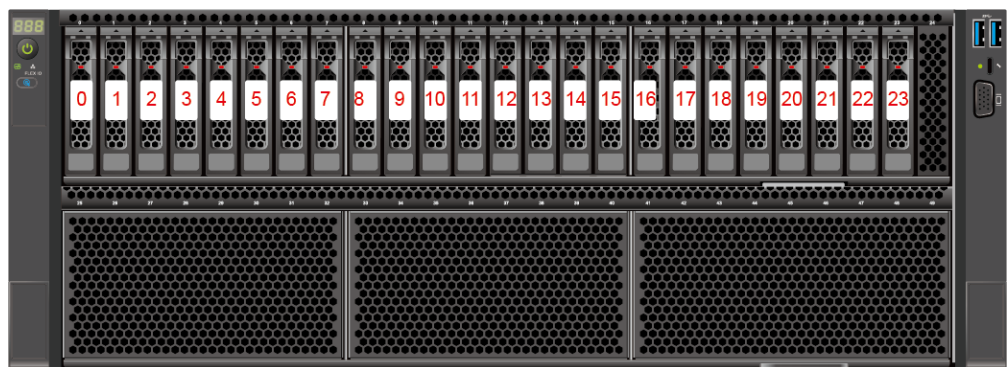

Table 5-21 Drive numbering

Drive No.	Drive Number Displayed on the iBMC WebUI
0	0
1	1
2	2
3	3
4	4
5	5
6	6
7	7
8	8
9	9
10	10
11	11
12	12

Drive No.	Drive Number Displayed on the iBMC WebUI
13	13
14	14
15	15
16	16
17	17
18	18
19	19
20	20
21	21
22	22
23	23

- Drive numbering of the 24 x 2.5" drive NVMe configuration 2 in [Table 5-20](#).

Figure 5-44 Drive numbering

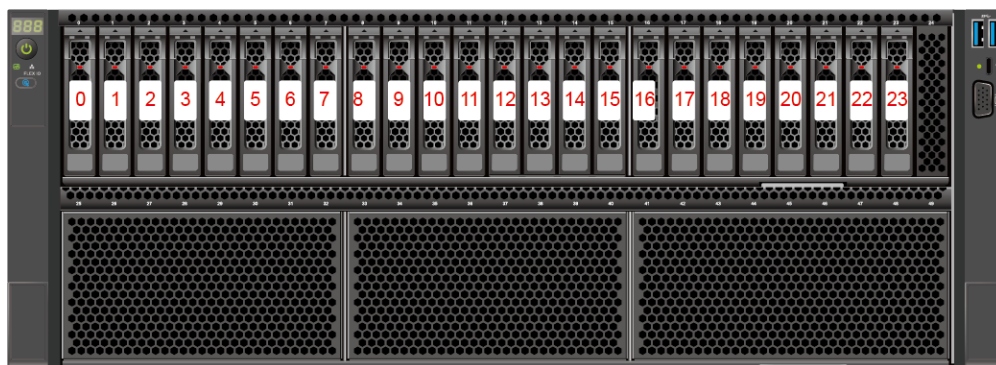

Table 5-22 Drive numbering

Drive No.	Drive Number Displayed on the iBMC WebUI
0	0
1	1
2	2
3	3
4	4
5	5

Drive No.	Drive Number Displayed on the iBMC WebUI
6	6
7	7
8	8
9	9
10	10
11	11
12	12
13	13
14	14
15	15
16	16
17	17
18	18
19	19
20	20
21	21
22	22
23	23

- Drive numbering of the 24 x 2.5" drive NVMe configuration 3 in [Table 5-20](#).

Figure 5-45 Drive numbering

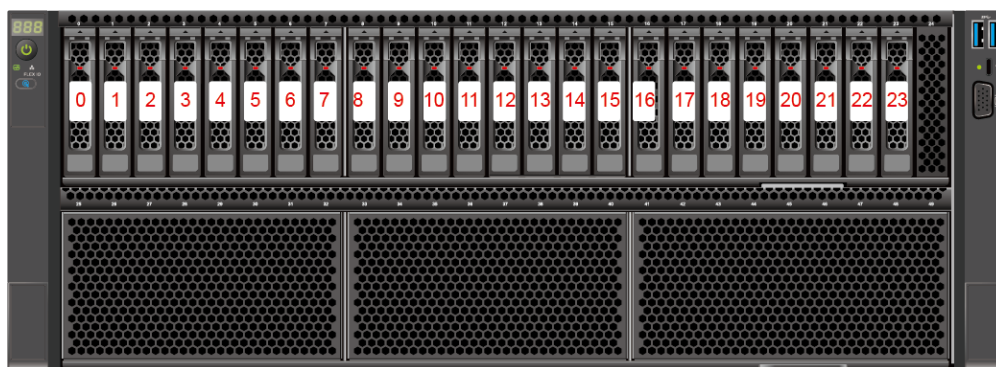

Table 5-23 Drive numbering

Drive No.	Drive Number Displayed on the iBMC WebUI	Drive Number Identified by the RAID Controller Card
0	0	0 ^{Note}
1	1	1 ^{Note}
2	2	2 ^{Note}
3	3	3 ^{Note}
4	4	-
5	5	-
6	6	-
7	7	-
8	8	-
9	9	-
10	10	-
11	11	-
12	12	4 ^{Note}
13	13	5 ^{Note}
14	14	6 ^{Note}
15	15	7 ^{Note}
16	16	-
17	17	-
18	18	-
19	19	-
20	20	-
21	21	-
22	22	-
23	23	-
<p>Note: If the slot is configured with a SAS/SATA drive, the RAID controller card can manage the drive and allocate a number to the drive.</p>		

5.5.1.5 25 x 2.5" Drive EXP Configuration

Drive Configuration

Table 5-24 Drive configuration

Configuration	Front Drive	Rear Drive	Built-in Drive	Drive Management Mode
25 x 2.5" drive EXP configuration ^a	<ul style="list-style-type: none"> Front drive: 25 x 2.5" <ul style="list-style-type: none"> Slots 0 to 24 support SAS/SATA drives. 	-	-	<ul style="list-style-type: none"> SAS/SATA drive: 1 x PCIe RAID controller card^b/1 x RAID controller cable card
<ul style="list-style-type: none"> a: The current configuration supports six 8080 fans or eight 8038 fans. The quantity of fans vary with actual configuration. b: The PCIe plug-in RAID controller card is installed in slot 4 by default. For details about the optional components, consult the local sales representative or see "Search Parts" in the compatibility list on the technical support website. 				

Drive Numbering

NOTICE

The drive numbers identified by the RAID controller card vary depending on the cabling of the RAID controller card. This section uses the drive numbers identified by a RAID controller card that adopts the default cabling described in "Internal Cabling" in the server *Maintenance and Service Guide*.

- Drive numbering of the 25 x 2.5 drive EXP configuration in [Table 5-24](#)

Figure 5-46 Drive numbering

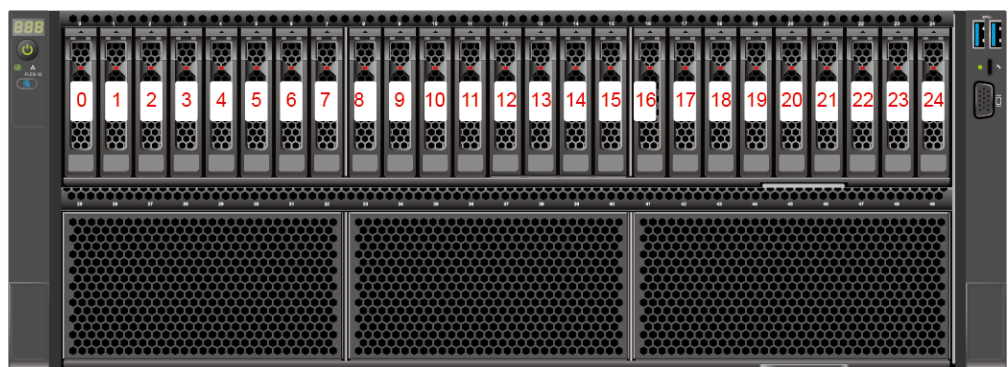

Table 5-25 Drive numbering

Drive No.	Drive Number Displayed on the iBMC WebUI	Drive Number Identified by the RAID Controller Card
0	0	0
1	1	1
2	2	2
3	3	3
4	4	4
5	5	5
6	6	6
7	7	7
8	8	8
9	9	9
10	10	10
11	11	11
12	12	12
13	13	13
14	14	14
15	15	15
16	16	16
17	17	17
18	18	18
19	19	19
20	20	20
21	21	21
22	22	22
23	23	23
24	24	24

5.5.1.6 50 x 2.5" Drive EXP Configuration

Drive Configuration

Table 5-26 Drive configuration

Configuration	Front Drive	Rear Drive	Built-in Drive	Drive Management Mode
50 x 2.5" Drive EXP configuration (25 x SAS/SATA + 25 x SAS/SATA) ^a	<ul style="list-style-type: none"> • Front drive: 50 x 2.5" <ul style="list-style-type: none"> – Slots 0 to 49 support SAS/SATA drives. 	<ul style="list-style-type: none"> • I/O module 4: 2 x 2.5" <ul style="list-style-type: none"> – Slots 50 and 51 support SAS/SATA drives 	-	<ul style="list-style-type: none"> • SAS/SATA drive: 2 x PCIe plug-in RAID controller cards^b <ul style="list-style-type: none"> – The rear I/O module is managed by the upper-layer front drive backplane.
<ul style="list-style-type: none"> • a: The current configuration supports only six 8080 fans. • b: The PCIe RAID controller card that manages drives 0 to 24 is configured in slot 4, and the PCIe plug-in RAID controller card that manages drives 25 to 49 is configured in slot 3 by default. • For details about the optional components, consult the local sales representative or see "Search Parts" in the compatibility list on the technical support website. 				

Drive Numbering

NOTICE

The drive numbers identified by the RAID controller card vary depending on the cabling of the RAID controller card. This section uses the drive numbers identified by a RAID controller card that adopts the default cabling described in "Internal Cabling" in the server *Maintenance and Service Guide*.

- Drive numbering of the 50 x 2.5" drive EXP configuration in [Table 5-26](#)

Figure 5-47 Drive numbering

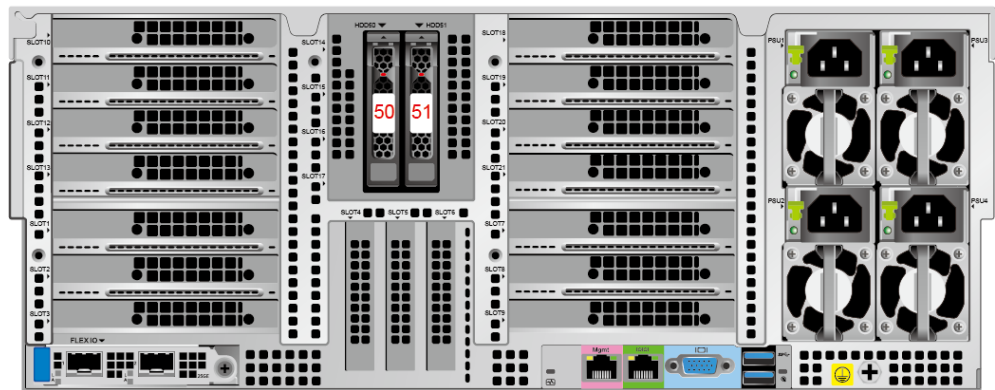
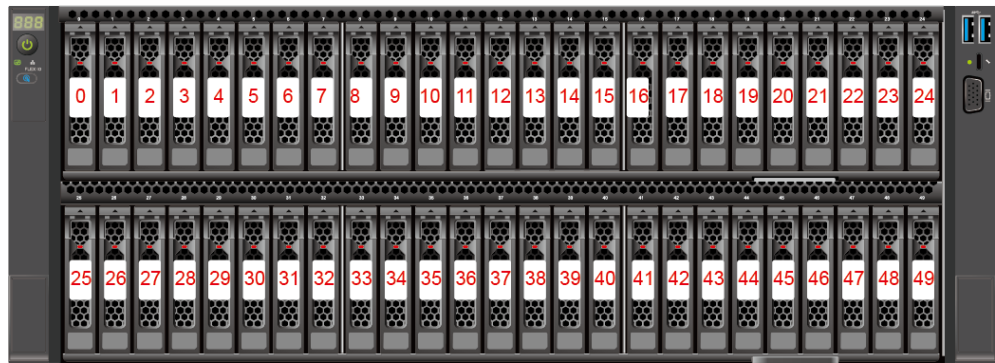

Table 5-27 Drive numbering

Drive No.	Drive Number Displayed on the iBMC WebUI	Drive Number Identified by the RAID Controller Card
0	0	0
1	1	1
2	2	2
3	3	3
4	4	4
5	5	5
6	6	6
7	7	7
8	8	8
9	9	9
10	10	10
11	11	11

Drive No.	Drive Number Displayed on the iBMC WebUI	Drive Number Identified by the RAID Controller Card
12	12	12
13	13	13
14	14	14
15	15	15
16	16	16
17	17	17
18	18	18
19	19	19
20	20	20
21	21	21
22	22	22
23	23	23
24	24	24
25	25	0
26	26	1
27	27	2
28	28	3
29	29	4
30	30	5
31	31	6
32	32	7
33	33	8
34	34	9
35	35	10
36	36	11
37	37	12
38	38	13
39	39	14
40	40	15

Drive No.	Drive Number Displayed on the iBMC WebUI	Drive Number Identified by the RAID Controller Card
41	41	16
42	42	17
43	43	18
44	44	19
45	45	20
46	46	21
47	47	22
48	48	23
49	49	24
50	50	25
51	51	26

5.5.1.7 49 x 2.5" Drive Configuration

Drive Configuration

Table 5-28 Drive configuration

Configuration	Front Drive	Rear Drive	Built-in Drive	Drive Management Mode
49 x 2.5" drive configuration (25 x SAS/SATA + 24 x NVMe) ^a	<ul style="list-style-type: none"> • Front drive: 49 x 2.5" <ul style="list-style-type: none"> – Slots 0 to 23 support only NVMe drives. – Slots 25 to 49 support SAS/SATA drives. 	-	-	<ul style="list-style-type: none"> • SAS/SATA drive: 1 x PCIe plug-in RAID controller card^b • NVMe drive: CPU pass-through

Configuration	Front Drive	Rear Drive	Built-in Drive	Drive Management Mode
<ul style="list-style-type: none"> • a: The current configuration supports only six 8080 fans. • b: The PCIe plug-in RAID controller card is installed in slot 4 by default. • For details about the optional components, consult the local sales representative or see "Search Parts" in the compatibility list on the technical support website. 				

Drive Numbering

NOTICE

The drive numbers identified by the RAID controller card vary depending on the cabling of the RAID controller card. This section uses the drive numbers identified by a RAID controller card that adopts the default cabling described in "Internal Cabling" in the server *Maintenance and Service Guide*.

- Drive numbering of the 49 x 2.5" drive configuration in [Table 5-28](#)

Figure 5-48 Drive numbering

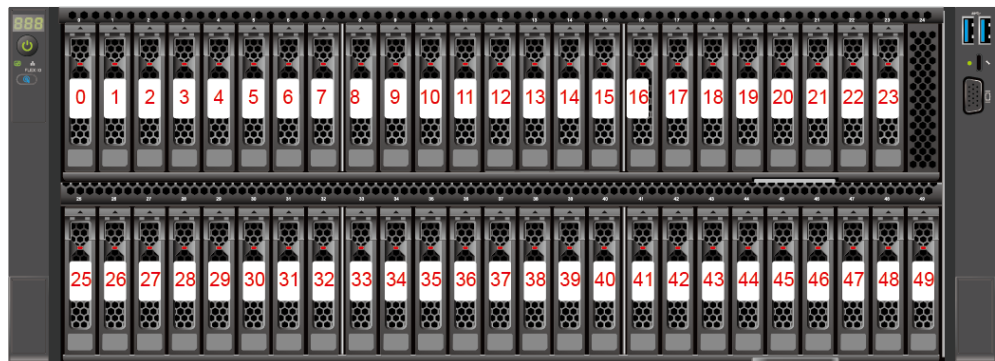

Table 5-29 Drive numbering

Drive No.	Drive Number Displayed on the iBMC WebUI	Drive Number Identified by the RAID Controller Card
0	0	-
1	1	-
2	2	-
3	3	-
4	4	-

Drive No.	Drive Number Displayed on the iBMC WebUI	Drive Number Identified by the RAID Controller Card
5	5	-
6	6	-
7	7	-
8	8	-
9	9	-
10	10	-
11	11	-
12	12	-
13	13	-
14	14	-
15	15	-
16	16	-
17	17	-
18	18	-
19	19	-
20	20	-
21	21	-
22	22	-
23	23	-
24	-	-
25	25	0
26	26	1
27	27	2
28	28	3
29	29	4
30	30	5
31	31	6
32	32	7
33	33	8

Drive No.	Drive Number Displayed on the iBMC WebUI	Drive Number Identified by the RAID Controller Card
34	34	9
35	35	10
36	36	11
37	37	12
38	38	13
39	39	14
40	40	15
41	41	16
42	42	17
43	43	18
44	44	19
45	45	20
46	46	21
47	47	22
48	48	23
49	49	24

5.5.2 Drive Indicators

SAS/SATA Drive Indicators

Figure 5-49 SAS/SATA drive indicators

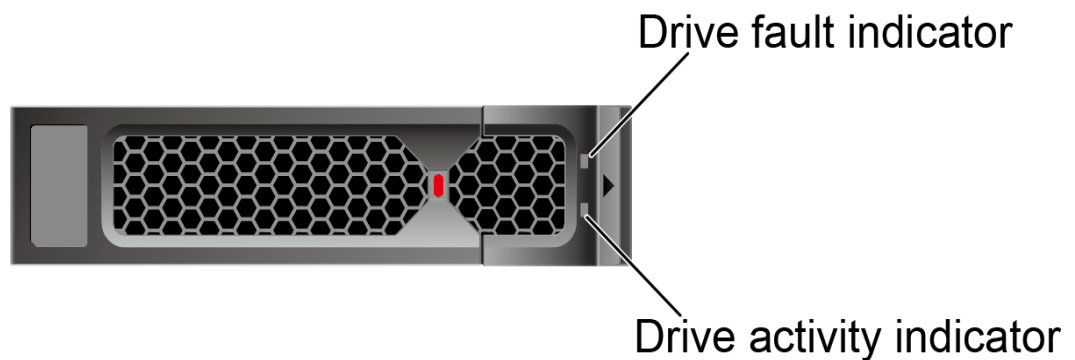
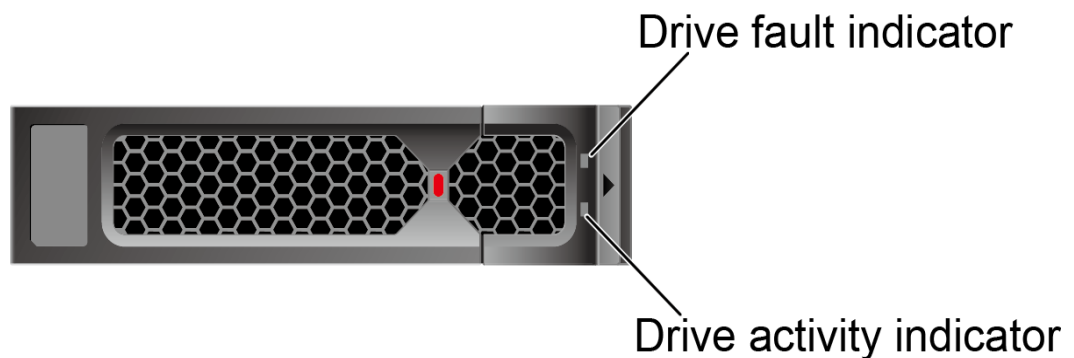

Table 5-30 SAS/SATA drive indicator description

Activity Indicator (Green)	Fault Indicator (Red/Blue)	Description
Off	Off	The drive is not detected.
Steady on	Off	The drive is detected.
Blinking at 4 Hz	Off	Data is being read or written properly, or data on the primary drive is being rebuilt.
Steady on	Blinking blue at 4 Hz	The drive is being located.
Blinking at 1 Hz	Blinking red at 1 Hz synchronously	Data on the secondary drive is being rebuilt.
Off	Red steady on	A drive in a RAID array is removed.
Steady on	Red steady on	The drive is faulty.

NVMe Drive Indicator

Figure 5-50 NVMe drive indicator



- If the VMD function is enabled and the latest VMD driver is installed, the NVMe drives support surprise hot swap.

Table 5-31 NVMe drive indicator description (VMD function enabled)

Activity Indicator (Green)	Fault Indicator (Red/Blue)	Description
Off	Off	The NVMe drive is not detected.
Steady on	Off	The NVMe drive is detected and operating properly.

Activity Indicator (Green)	Fault Indicator (Red/Blue)	Description
Blinking at 4 Hz	Off	Data is being read from or written to the NVMe drive.
Steady on/ blinking	Blinking blue at 4 Hz	The NVMe drive is being located.
Blinking at 1 Hz	Blinking red at 1 Hz synchronously	Data on the NVMe secondary drive is being rebuilt.
Steady on/Off	Red steady on	The NVMe drive is faulty.

- If the VMD function is disabled, the NVMe drives support only orderly hot swap.

Table 5-32 NVMe drive indicator description (VMD function disabled)

Activity Indicator (Green)	Fault Indicator (Red/Blue)	Description
Off	Off	The NVMe drive is not detected.
Steady on	Off	The NVMe drive is detected and operating properly.
Blinking at 4 Hz	Off	Data is being read from or written to the NVMe drive.
Steady on/ blinking	Blinking blue at 4 Hz	The NVMe drive is being located.
Off	Blinking red at 0.5 Hz	The NVMe drive has completed the hot swap process and is removable.
Off	Blinking red at 2 Hz	The NVMe drive is being hot-swapped.
Steady on/Off	Red steady on	The NVMe drive is faulty.

5.5.3 RAID Controller Card

The RAID controller card supports RAID configuration, RAID level migration, and drive roaming.

- For details about the optional components, consult the local sales representative or see "Search Parts" in the compatibility list on the technical support website.
- For details about the RAID controller card, see the server *RAID Controller Card User Guide*.

5.6 Network

5.6.1 OCP 3.0 NICs

OCP 3.0 NICs provide network expansion capabilities.

- The FlexIO slot supports an OCP 3.0 NIC, which can be configured as required.
- For details about the optional components, consult the local sales representative or see "Search Parts" in the compatibility list on the technical support website.
- For details about OCP 3.0 NICs, see the *OCP 3.0 NIC User Guide*.

5.7 I/O Expansion

5.7.1 PCIe Cards

PCIe cards provide ease of expandability and connection.

- A maximum of 21 standard PCIe slots.
- For details about the optional components, consult the local sales representative or see "Search Parts" in the compatibility list on the technical support website.
- When IB cards are used to build an IB network, ensure that the IPoIB modes of the IB cards at both ends of the network connection are the same. For details, contact technical support.

5.7.2 PCIe Slots

PCIe Slots

Figure 5-51 PCIe slots

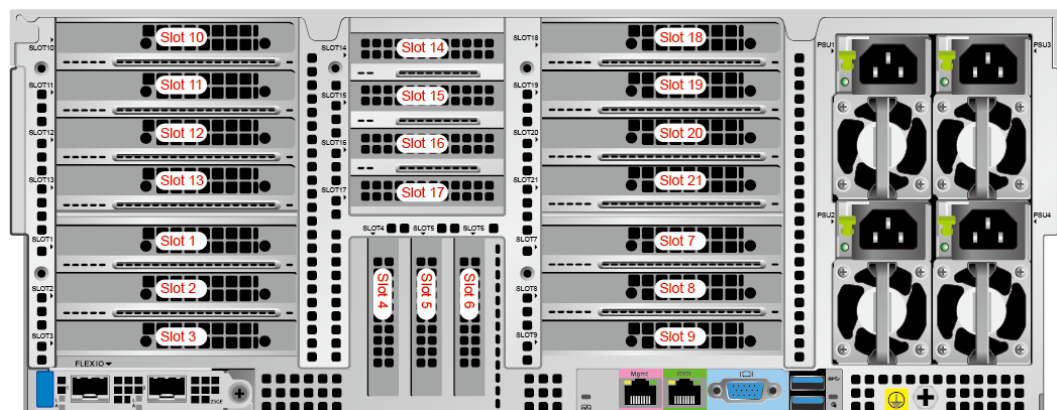

- I/O module 1 provides slots 1, 2, and 3.
- I/O module 2 provides slots 7, 8, and 9.
- I/O module 3 provides slots 10, 11, 12, and 13.

- I/O module 4 provides slots 14, 15, 16, and 17.
- I/O module 5 provides slots 18, 19, 20, and 21.
- The mainboard provides slots 4, 5, and 6.

PCIe Riser Card

- PCIe riser card 1 of I/O module 1/2
 - Provides PCIe slots 1, 2, and 3 when installed in I/O module 1.
 - Provides PCIe slots 7, 8, and 9 when installed in I/O module 2.

Figure 5-52 PCIe riser card 1

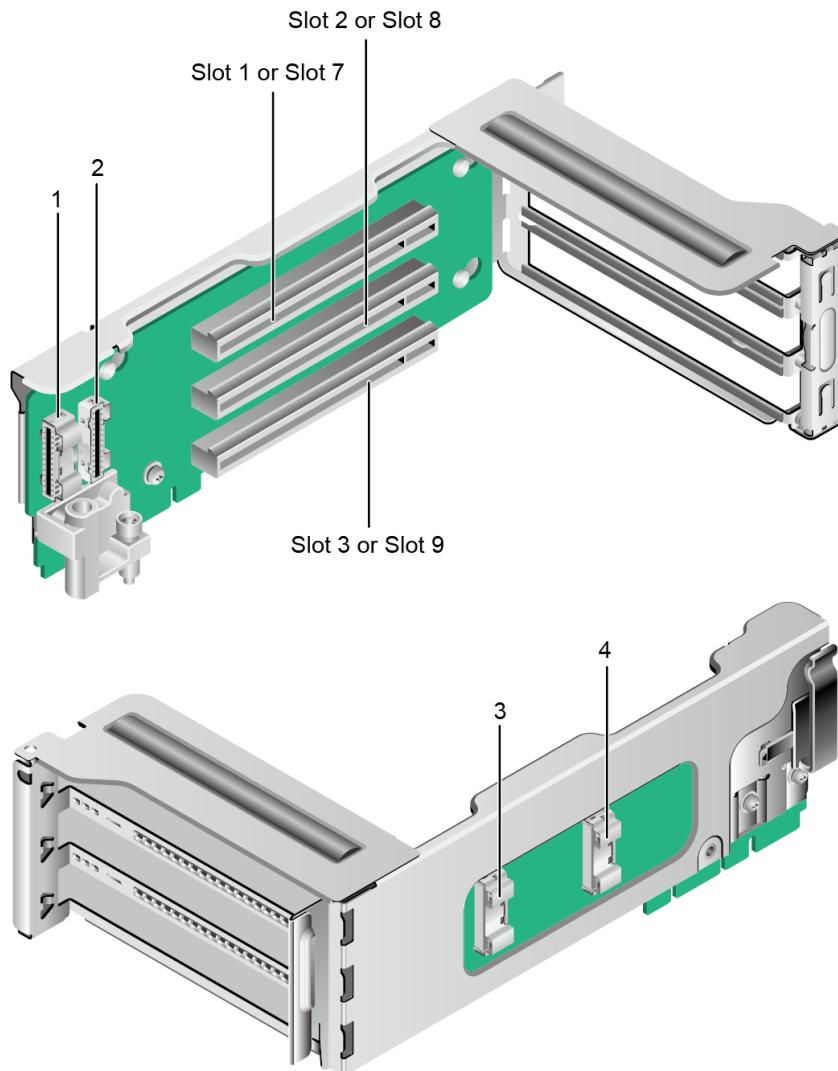

1	UBC connector (B_UBC4/J502)	2	UBC connector (A_UBC4/J501)
3	UBC connector (A_UBC1/2 J601)	4	UBC connector (B_UBC1/2 J602)

- PCIe riser card 2 of I/O module 3/4/5
 - Provides PCIe slots 10, 11, 12 and 13 when installed in I/O module 3.
 - Provides PCIe slots 14, 15, 16 and 17 when installed in I/O module 4.
 - Provides PCIe slots 18, 19, 20 and 21 when installed in I/O module 5.

Figure 5-53 PCIe riser card 2

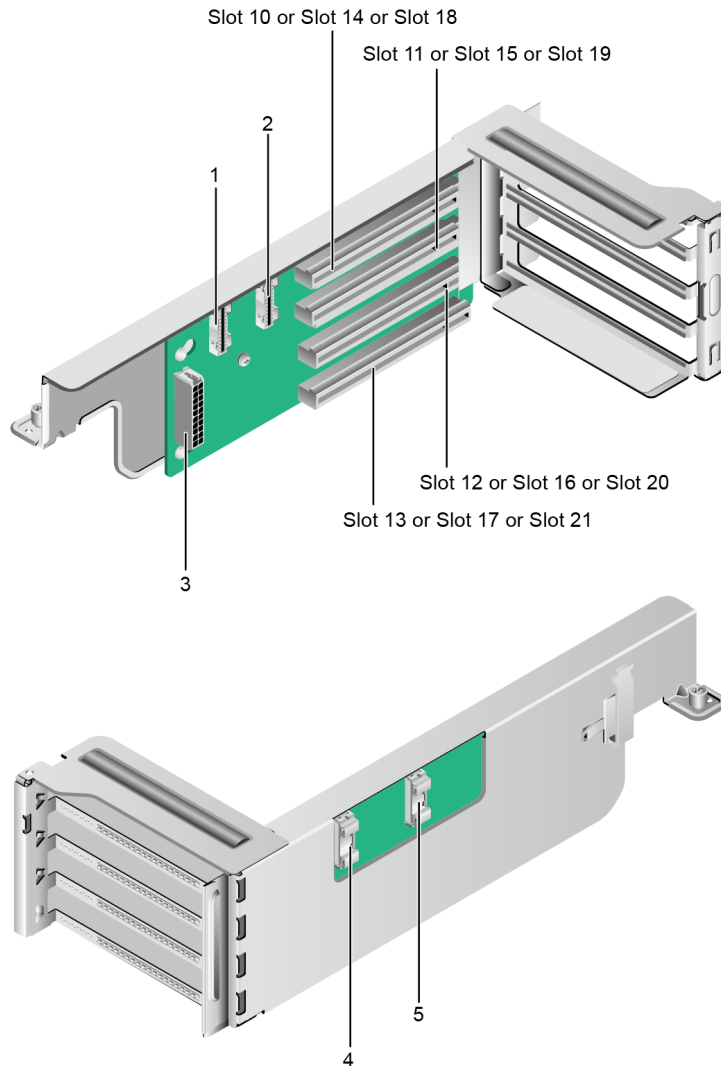

1	UBC connector (2B_UBC3/4 J4)	2	UBC connector (2A_UBC3/4 J3)
3	Power connector (POWER CONN/J9)	4	UBC connector (1A_UBC3/4 J1)
5	UBC connector (1B_UBC3/4 J2)	-	-

- PCIe riser card 3 of I/O module 3/5 (supporting GPU cards)
 - Provides PCIe slots 11 and 13 when installed in I/O module 3.

- Provides PCIe slots 19 and 21 when installed in I/O module 5.

Figure 5-54 PCIe riser card 3 (supporting GPU cards)

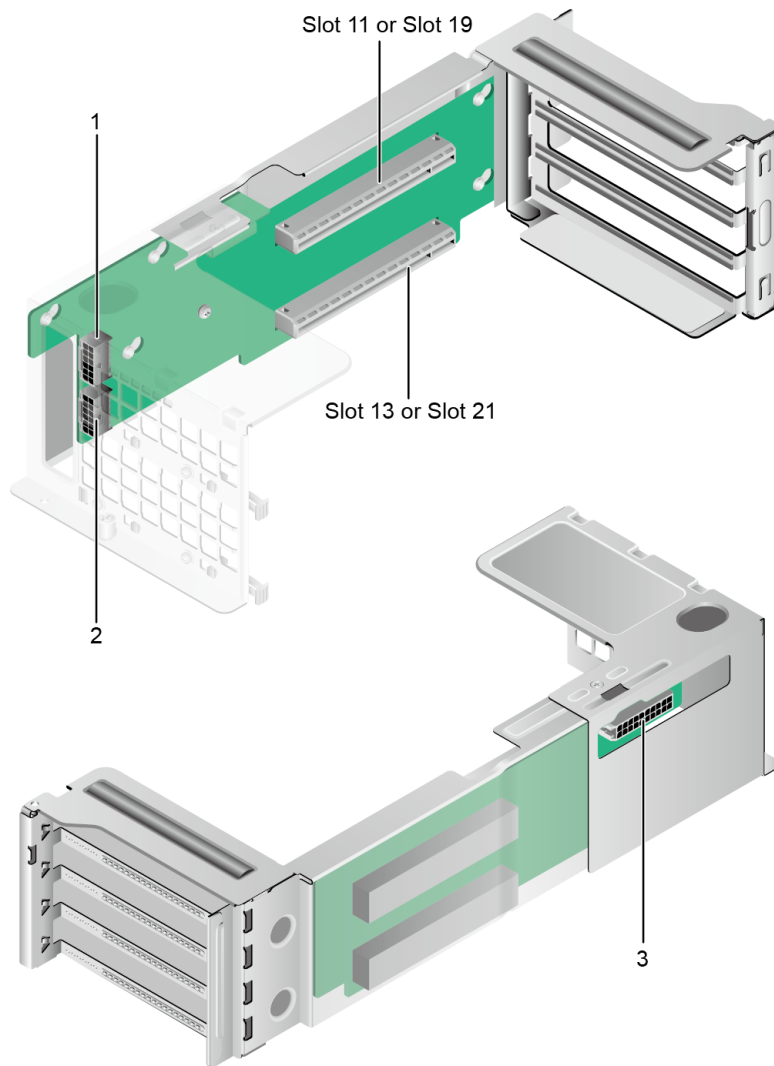

1	GPU power connector (GPU PWR CONN2/J4)	2	GPU power connector (GPU PWR CONN1/J3)
3	Power connector (POWER CONN/J9)	-	-

5.7.3 PCIe Slot Description

NOTE

- When CPU 3 and CPU 4 are not detected, the corresponding PCIe slots are unavailable.
- The PCIe devices subordinate to CPU3 and CPU4 cannot be identified in Legacy BIOS mode.

Table 5-33 PCIe slot description

PCIe Riser Card	PCIe Riser Card Installation Position	PCIe Slot	PCIe Slot or Port Description	CPU	PCIe Port Number	PCIe Devices Supported by the PCIe Slot or Interface
PCIe riser card 1 of I/O module 1	I/O module 1	Slot 1	PCIe4.0 x16 ^a (x16) ^b	CPU 4	Port3A	FHHL
		Slot 2	PCIe 5.0 x16 (x16)	CPU 1	Port2A	FHHL
		Slot 3	PCIe 4.0 x16 (x16)	CPU 1	Port5A	HHHL
-	PCIe slots on the mainboard	Slot 4	PCIe 4.0 x8 (x8)	CPU 1	Port3A	HHHL
		Slot 5	PCIe 4.0 x8 (x8)	CPU 1	Port3E	HHHL
		Slot 6	PCIe 4.0 x8 (x8)	CPU 2	Port1A	HHHL
PCIe riser card 1 of I/O module 2	I/O module 2	Slot 7	PCIe 4.0 x16 (x16)	CPU 4	Port4A	FHHL
		Slot 8	PCIe 5.0 x16 (x16)	CPU 2	Port2A	FHHL
		Slot 9	PCIe 4.0 x16 (x16)	CPU 2	Port3A	FHHL
PCIe riser card 2 of I/O module 3	I/O module 3	Slot 10	PCIe 4.0 x16 (x8)	CPU 4	Port1A	FHHL
		Slot 11	PCIe 4.0 x16 (x8)	CPU 4	Port1E	FHHL
		Slot 12	PCIe 4.0 x16 (x8)	CPU 4	Port2A	FHHL
		Slot 13	PCIe 4.0 x16 (x8)	CPU 4	Port2E	FHHL
PCIe riser card 2 of I/O module 4	I/O module 4	Slot 14	PCIe 4.0 x16 (x8)	CPU 3	Port1A	HHHL
		Slot 15	PCIe 4.0 x16 (x8)	CPU 3	Port1E	HHHL

PCIe Riser Card	PCIe Riser Card Installation Position	PCIe Slot	PCIe Slot or Port Description	CPU	PCIe Port Number	PCIe Devices Supported by the PCIe Slot or Interface
		Slot 16	PCIe 4.0 x16 (x8)	CPU 3	Port5A	HHHL
		Slot 17	PCIe 4.0 x16 (x8)	CPU 3	Port5E	HHHL
PCIe riser card 2 of I/O module 5	I/O module 5	Slot 18	PCIe 4.0 x16 (x8)	CPU 3	Port2A	FHHL ^c
		Slot 19	PCIe 4.0 x16 (x8)	CPU 3	Port2E	FHHL
		Slot 20	PCIe 4.0 x16 (x8)	CPU 3	Port3A	FHHL
		Slot 21	PCIe 4.0 x16 (x8)	CPU3	Port3E	FHHL
PCIe riser card 3 of I/O module 3	I/O module 3	Slot 11	PCIe 5.0 x16 (x16)	CPU 4	Port1A	FHFL
		Slot 13	PCIe 5.0 x16 (x16)	CPU 4	Port2A	FHFL
PCIe riser card 3 of I/O module 5	I/O module 5	Slot 19	PCIe 5.0 x16 (x16)	CPU 3	Port2A	FHFL ^d
		Slot 21	PCIe 5.0 x16 (x16)	CPU 3	Port3A	FHFL
-	-	FlexIO card	PCIe 4.0 x16 (x16)	CPU 1	Port1A	OCP 3.0 specifications
-	Air duct	RAID controller cable card	PCIe 4.0 x8 (x8)	CPU1	Port4E	-

PCIe Riser Card	PCIe Riser Card Installation Position	PCIe Slot	PCIe Slot or Port Description	CPU	PCIe Port Number	PCIe Devices Supported by the PCIe Slot or Interface
<ul style="list-style-type: none"> • a: PCIe 4.0 refers to the PCIe of the fourth generation, and x16 refers to the physical slot width. • b: The x16 in brackets indicates that the link bandwidth is x16. • c: When I/O module 4 is configured with PCIe cards, I/O module 5 supports only HHL PCIe cards. • d: When I/O module 3/5 is configured with a GPU card, the I/O module 4 is configured with a filler panel. • The PCIe x16 slots are compatible with PCIe x16, PCIe x8, PCIe x4, and PCIe x1 cards. The bandwidth of the PCIe slot cannot be less than that of the inserted PCIe card. • The full-height full-length (FHFL) PCIe slots are compatible with FHFL PCIe cards, full-height half-length (FHHL) PCIe cards, and half-height half-length (HHHL) PCIe cards. • The FHHL PCIe slots are compatible with FHHL PCIe cards and HHHL PCIe cards. • The maximum power supply of each PCIe slot is 75 W. 						

Server Bus/Device/Function Number (B/D/F) Information

The server's B/D/F information may change with PCIe card configurations. You can obtain the B/D/F information of the server using the following methods:

- SOL serial port information: If serial port information has been collected, search the keyword RootBusBDF or DeviceBDF in **systemcom.tar** file to query the B/D/F information of the server.
- The following describes how to obtain the B/D/F information on different OSs:
 - Linux OS: You can obtain the B/D/F information of the server using the **lspci -vvv** command.

NOTE

- If the OS does not support the **lspci** command by default, obtain the **pci-utils** package from the **yum** source and install it to make the OS support the command.
- Windows OS: After installing the **pci-utils** package, run the **lspci** command to obtain the B/D/F information of the server.
- VMware OS: The **lspci** command is supported by default. You can directly obtain the B/D/F information of the server using the **lspci** command.

5.8 PSUs

- Supports two or four PSUs.
- Supports AC or DC PSUs.
- Supports hot swap.
- When two PSUs are configured, 1+1 redundancy is supported. When four PSUs are configured, 2+2 redundancy is supported.
- PSUs of the same P/N code must be used in a server.
- Short-circuit protection is provided, and bipolar fuses are provided for PSUs that support dual live wire input.
- If the DC power supply is used, purchase the DC power supply that meets the requirements of the safety standards or the DC power supply that has passed the CCC certification.
- The rated power of the power supply unit is related to the input voltage. Please refer to the technical manual of the relevant power supply for the detailed relation between voltage and power.
- For details about the optional components, consult the local sales representative or see "Search Parts" in the compatibility list on the technical support website.

Figure 5-55 Positions of PSUs

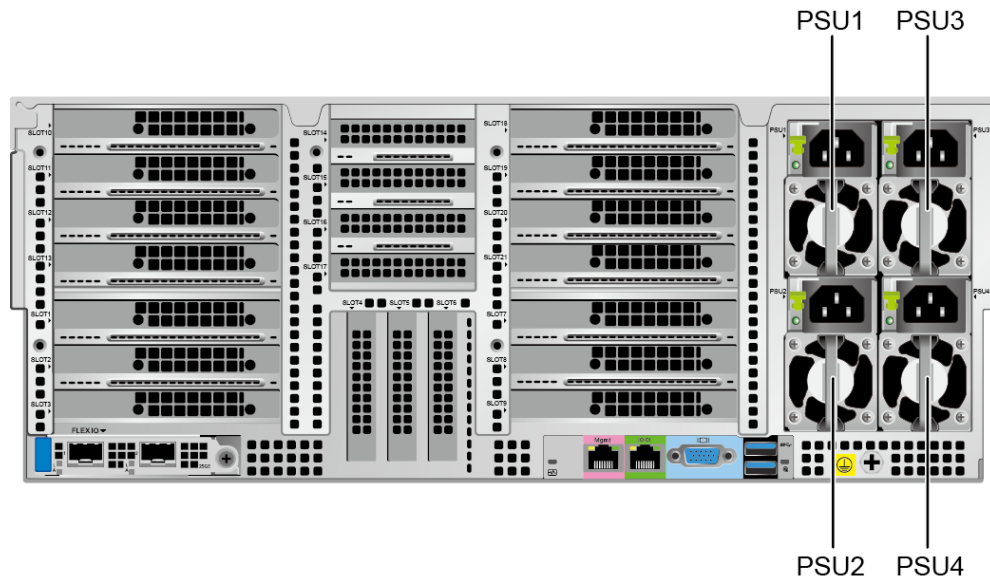

 NOTE

- When 900 W AC Titanium PSUs are configured, if the input voltage ranges from 100 V AC to 127 V AC, the output power decreases to 550 W.
- When 2000 W AC Platinum PSUs are configured, if the input voltage ranges from 200 V AC to 220 V AC, the output power decreases to 1800 W.
- When 3000 W AC Titanium PSUs are configured,
 - if the input voltage ranges from 100 V AC to 127 V AC, the output power decreases to 1300 W.
 - if the input voltage ranges from 200 V AC to 220 V AC, the output power decreases to 2500 W.
 - if the input voltage ranges from 220 V AC to 230 V AC, the output power decreases to 2900 W.

5.9 Fan Modules

- Supports four fan modules. Each module contains two layers of fans. (Fan xA on the upper layer, Fan xB on the lower layer, and x indicates the fan module number), available with 6 or 8 fans.

 NOTE

- When six fans are configured:
 - The P/N codes of the fan modules installed in Fan 1 and Fan 4 must be the same. Fan 2 and Fan 3 must have the same fan module P/N code.
 - Fans 1A and 4A are installed with fan filler modules, and fans in other locations.
- When eight fans are configured:
 - Fan 1/2/3/4 fan module P/N codes must be the same.
 - Fans are installed on all Fan 1A/1B/2A/2B/3A/3B/4A/4B.
- For details about the matching relationship between the quantity of fans and drive configuration, see [5.5.1 Drive Configuration and Drive Numbering](#).
- Supports hot swap.
- Supports N+1 redundancy. The server runs properly when one fan module fails.
- Supports intelligent fan speed adjustment.

Figure 5-56 Positions of the fan modules

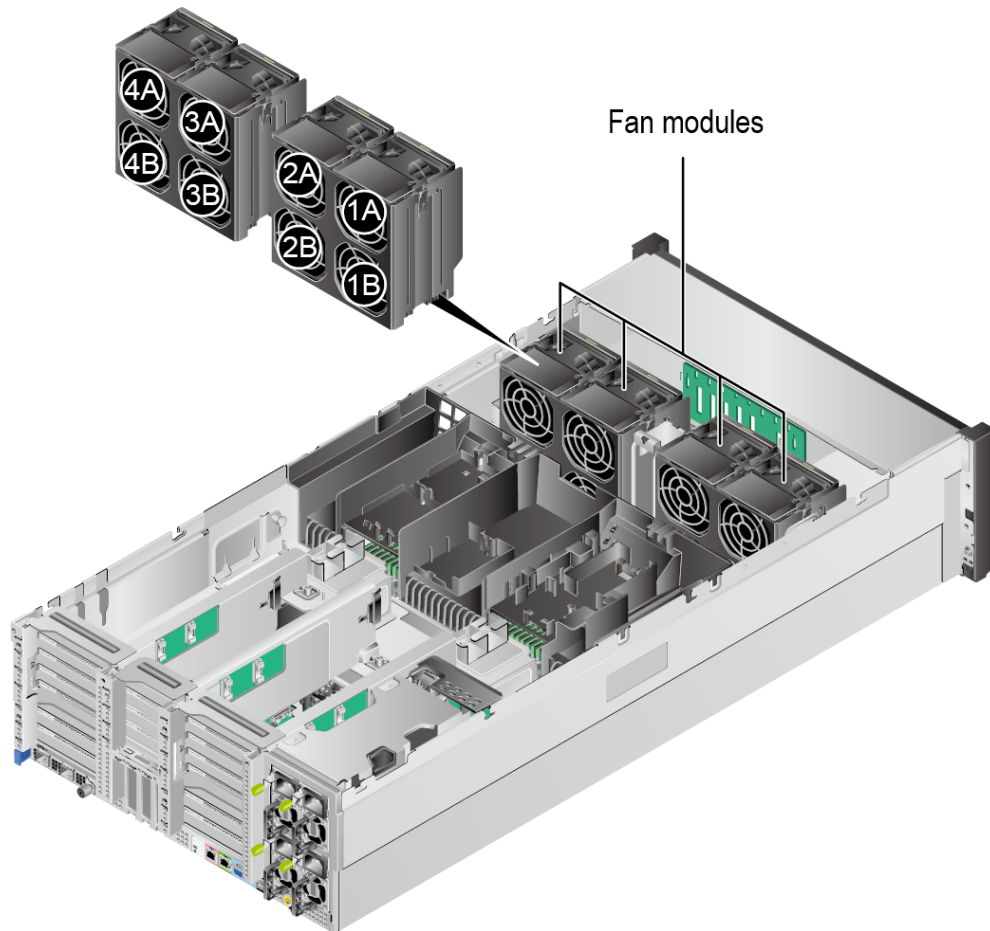

5.10 LCD

NOTE

Only the 8 x 2.5" drive pass-through configuration supports the LCD.

Function

The LCD displays the installation status and running status of server components and enables users to set the IP address of the iBMC management network port on the server.

The LCD and the server iBMC form an LCD subsystem. The LCD directly obtains device information from the iBMC. The LCD subsystem does not store device data.

Figure 5-57 LCD subsystem working principle

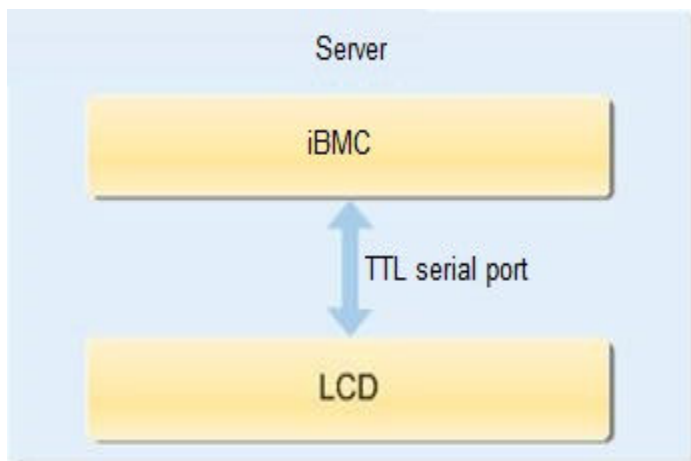

5.11 Boards

5.11.1 Mainboard

Figure 5-58 Mainboard

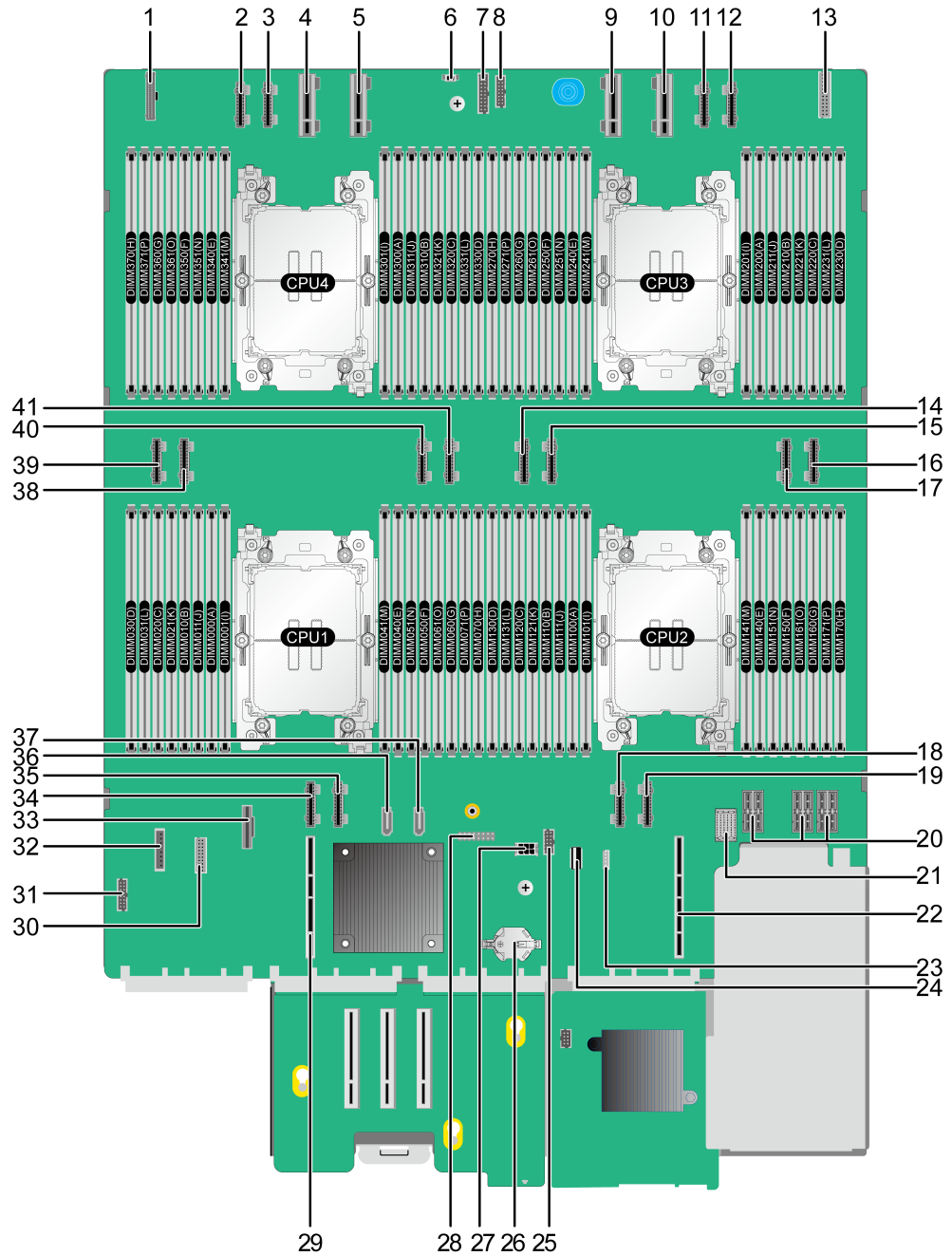

1	Right mounting ear connector (R_EAR BOARD/J6080)	2	UBC4-1A connector (UBC4-1A/J14302)
---	--	---	------------------------------------

3	UBC4-1B connector (UBC4-1B/J14301)	4	UBCDD4-2 connector (UBCDD4-2/J20805)
5	UBCDD4-1 connector (UBCDD4-1/J20804)	6	Intrusion sensor connector (INTRUDER CONN/S2)
7	Front-drive backplane connector 2 (FRONT HDD BP2/J17701)	8	Front-drive backplane connector 1 (FRONT HDD BP1/J6082)
9	UBCDD3-2 connector (UBCDD3-2/J20803)	10	UBCDD3-1 connector (UBCDD3-1/J20802)
11	UBC3-1B connector (UBC3-1B/J13702)	12	UBC3-1A connector (UBC3-1A /J13701)
13	Left mounting ear connector (L_EAR BOARD/J6081)	14	UBC2-2A connector (UBC2-2A/J14001)
15	UBC2-2B connector (UBC2-2B/J14002)	16	UBC3-2A connector (UBC3-2A/J13601)
17	UBC3-2B connector (UBC3-2B/J13602)	18	UBC2-1B connector (UBC2-1B/J13502)
19	UBC2-1A connector (UBC2-1A/J13501)	20	PSU backplane power connector (PDB POWER CONN/J18701/J18702/J18703)
21	PSU backplane signal connector (PDB MIS CONN/J2014)	22	PCIe riser 2 slot (PCIE RISER2 (CPU2)/J13001)
23	VROC key connector (VROC KEY/J6066)	24	Built-in USB 3.0 port (INNER USB3.0/J6067)
25	NC-SI connector (NCSI CONN/J31)	26	Cell battery holder (CMOS BAT/U6222)
27	Rear drive backplane power connector (REAR BP POWER/J17902)	28	TPM/TCM connector (J6065)
29	PCIe riser 1 slot (PCIE RISER1 (CPU1)/J12901)	30	M.2 low-speed signal connector (M.2 MIS/J51)
31	Fan low-speed signal connector (FANBOARD/J6077)	32	LCD connector (LCD CONN/J17702)
33	M.2 Connector (PORT (A-B)/J14901)	34	UBC1-1B connector (UBC1-1B CONN/J40)
35	UBC1-1A connector (UBC1-1A CONN/J39)	36	SATA connector 1 (SATA1/J6098)

37	SATA connector 2 (SATA2/ J6099)	38	UBC4-2B connector (UBC4-2B CONN/J14402)
39	UBC4-2A connector (UBC4-2A CONN/J14401)	40	UBC1-2B connector (UBC1-2B CONN/J13403)
41	UBC1-2A connector (UBC1-2A CONN/J13402)	-	-

5.11.2 Drive Backplane

Front-Drive Backplane

- 8 x 2.5" drive pass-through backplane

All drive configurations in [5.5.1.1 8 x 2.5" Drive Pass-Through Configuration](#) support this backplane.

Figure 5-59 8 x 2.5" drive pass-through backplane

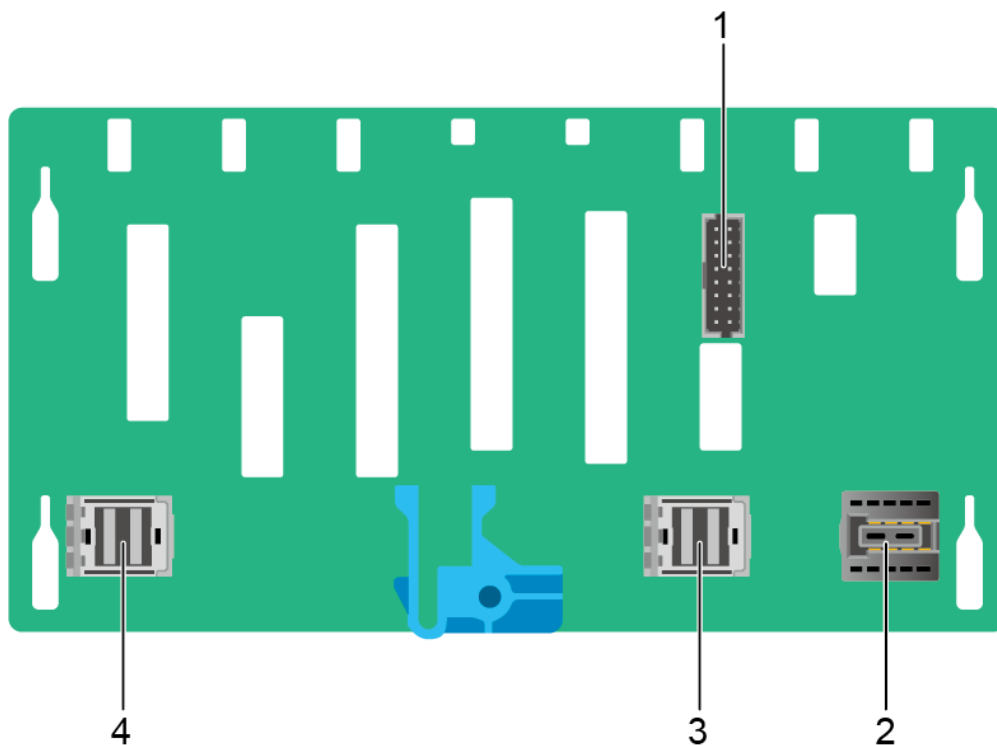

No.	Connector	The Managed Drive Slots
1	Backplane signal cable connector (HDD BP/ J12)	-

No.	Connector	The Managed Drive Slots
2	Power connector (HDD_POWER/J14)	-
3	Mini-SAS HD connector (PORT A/J28)	Slots 0 to 3
4	Mini-SAS HD connector (PORT B/J1)	Slots 4 to 7

- 12 x 2.5" drive pass-through backplane
 All drive configurations in [5.5.1.2 12 x 2.5" Drive Pass-Through Configuration](#) support this backplane.

Figure 5-60 12 x 2.5" drive pass-through backplane

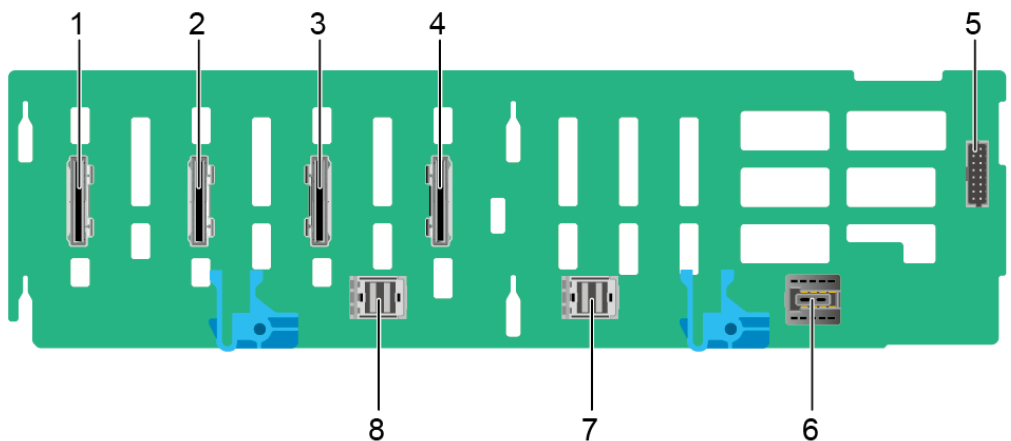

No.	Connector	The Managed Drive Slots
1	UBC connector 4 (UBC4/J4)	Slots 10 to 11
2	UBC connector 3 (UBC3/J3)	Slots 8 to 9
3	UBC connector 2 (UBC2/J2)	Slots 6 to 7
4	UBC connector 1 (UBC1/J1)	Slots 4 to 5
5	Backplane signal connector (HDD BP/J19)	-
6	Power connector (HDD_POWER/J21)	-

No.	Connector	The Managed Drive Slots
7	Mini-SAS HD connector (PORT A/J28)	Slots 0 to 3
8	Mini SAS HD connector (PORT B/J601)	Slots 4 to 7

- 24 x 2.5" drive pass-through backplane
 All drive configurations in [5.5.1.3 24 x 2.5" Drive Pass-Through Configuration](#) support this backplane.

Figure 5-61 24 x 2.5" drive pass-through backplane

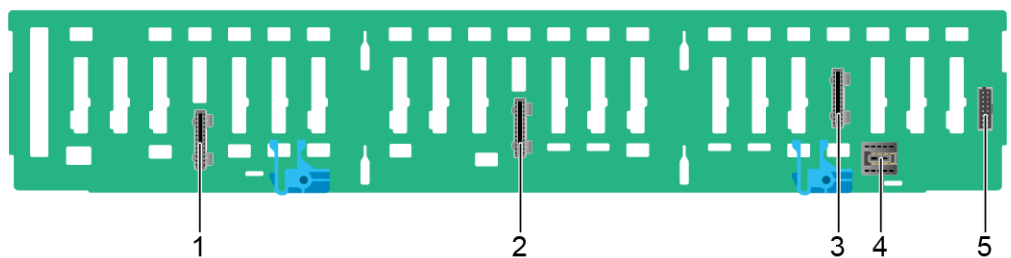

No.	Connector	The Managed Drive Slots
1	UBC connector 3 (UBC3/J601)	Slots 16 to 23
2	UBC connector 2 (UBC2/J501)	Slots 8 to 15
3	UBC connector 1 (UBC1/J401)	Slots 0 to 7
4	Power connector (HDD_POWER/J1)	-
5	Backplane signal cable connector (HDD_BP/J2)	-

- 24 x 2.5" drive NVMe backplane
 All drive configurations in [5.5.1.4 24 x 2.5" Drive NVMe Configuration](#) and [5.5.1.7 49 x 2.5" Drive Configuration](#) support this backplane.

NOTE

In a 50 x 2.5" drive NVMe configuration, the 24 x 2.5" drive NVMe backplanes are located in the upper 2U spaces.

Figure 5-62 24 x 2.5" drive NVMe backplane

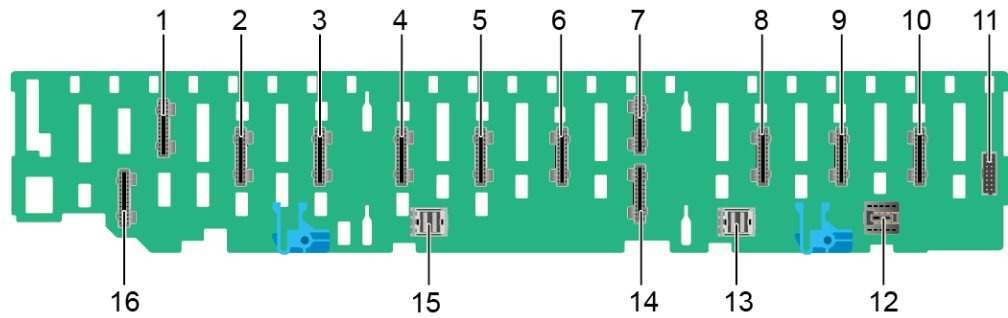

No.	Connector	The Managed Drive Slots
1	UBC connector 1-E (UBC1-E/J11)	Slots 20 to 21
2	UBC connector 1-D (UBC1-D/J10)	Slots 18 to 19
3	UBC connector 1-C (UBC1-C/J9)	Slots 16 to 17
4	UBC connector 1-B (UBC1-B/J8)	Slots 14 to 15
5	UBC connector 1-A (UBC1-A/J7)	Slots 12 to 13
6	UBC connector 2-F (UBC2-F/J6)	Slots 10 to 11
7	UBC connector 2-E (UBC2-E/J5)	Slots 8 to 9
8	UBC connector 2-C (UBC2-C/J3)	Slots 4 to 5
9	UBC connector 2-B (UBC2-B/J2)	Slots 2 to 3
10	UBC connector 2-A (UBC2-A/J1)	Slots 0 to 1
11	Backplane signal cable connector (HDD BP/ J40)	-
12	Power connector (HDD_POWER/J41)	-
13	Mini-SAS HD connector (PORT A/J13)	Slots 0 to 3

No.	Connector	The Managed Drive Slots
14	UBC connector 2-D (UBC2-D/J4)	Slots 6 to 7
15	Mini-SAS HD connector (PORT B/J14)	Slots 12 to 15
16	UBC connector 1-F (UBC1-F/J12)	Slots 22 to 23

- 25 x 2.5" drive EXP backplane

All drive configurations in [5.5.1.5 25 x 2.5" Drive EXP Configuration](#), [5.5.1.6 50 x 2.5" Drive EXP Configuration](#) and [5.5.1.7 49 x 2.5" Drive Configuration](#) support this backplane.

NOTE

- A 50 x 2.5" drive EXP configuration supports two 25 x 2.5" drive EXP backplanes.
- In a 50 x 2.5" drive NVMe configuration, the 25 x 2.5" drive EXP backplanes are located in the lower 2U spaces.

Figure 5-63 25 x 2.5" drive EXP backplane

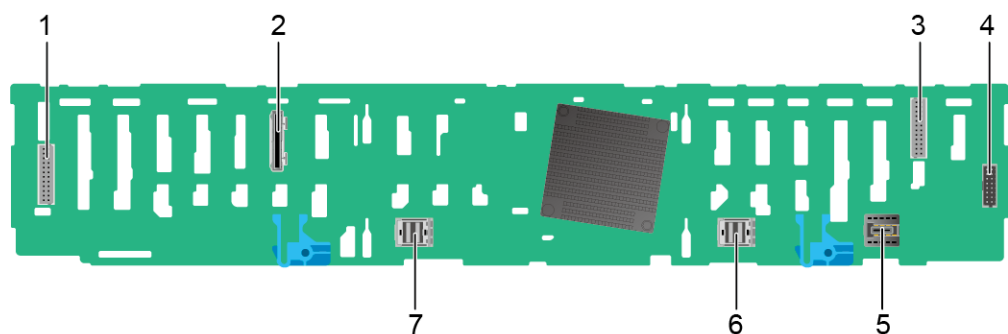

1	Low-speed signal connector for I/O module 1 (REAR_BP0/J2302)
2	UBC connector (J2201)
3	Low-speed signal connector for I/O module 2 (REAR_BP1/J2301)
4	Backplane signal connector (HDD BP/J302)
5	Power connector (HDD POWER/J301)
6	Mini SAS HD connector (PORT B/J2203)

7	Mini SAS HD connector (PORT A/ J2202)
---	--

- E1.S drive pass-through backplane (36 x E1.S)

Figure 5-64 E1.S drive pass-through backplane

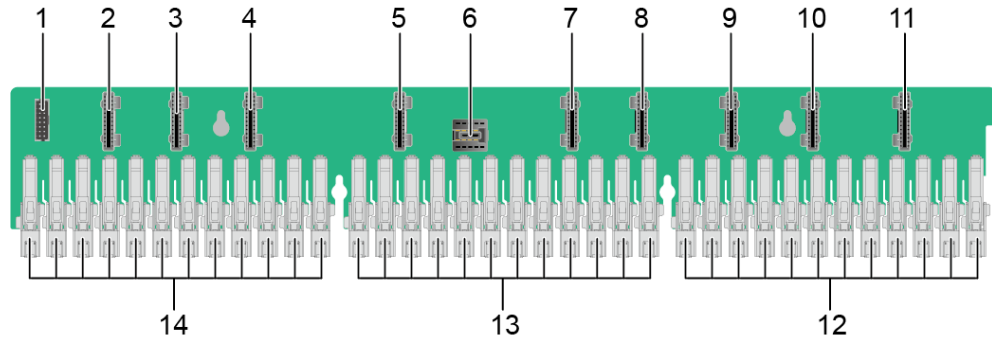

No.	Connector	The Managed Drive Slots
1	Backplane signal connector (HDD BP/ J49)	-
2	UBC connector 1 (UBC1/J2)	Slots 0 to 3
3	UBC connector 2 (UBC2/J3)	Slots 4 to 7
4	UBC connector 3 (UBC3/J4)	Slots 8 to 11
5	UBC connector 4 (UBC4/J5)	Slots 12 to 15
6	Power connector (HDD_POWER/J48)	-
7	UBC connector 5 (UBC5/J6)	Slots 16 to 19
8	UBC connector 6 (UBC6/J7)	Slots 20 to 23
9	UBC connector 7 (UBC7/J8)	Slots 24 to 27
10	UBC connector 8 (UBC8/J9)	Slots 28 to 31
11	UBC connector 9 (UBC9/J10)	Slots 32 to 35

No.	Connector	The Managed Drive Slots
12	E1.S connectors 24 to 35 (J35 to J46)	Slots 24 to 35
13	E1.S connectors 12 to 23 (J23 to J34)	Slots 12 to 23
14	E1.S connectors 11 to 22 (J23 to J34)	Slots 0 to 11

Rear-Drive Backplanes

- 2 x 2.5" drive backplane

Figure 5-65 2 x 2.5" drive backplane

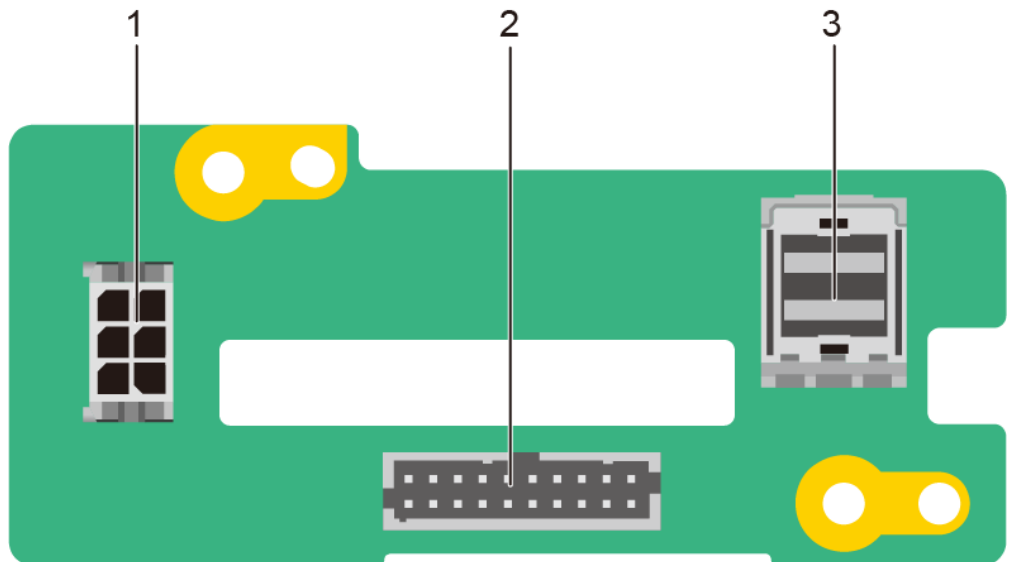

No.	Connector
1	Power connector (HDD PWR/J21)
2	Backplane signal cable connector (HDD BP/J17)
3	Mini-SAS HD connector (PORT A/ J28)

5.11.3 PSU Backplane

Figure 5-66 PSU backplane

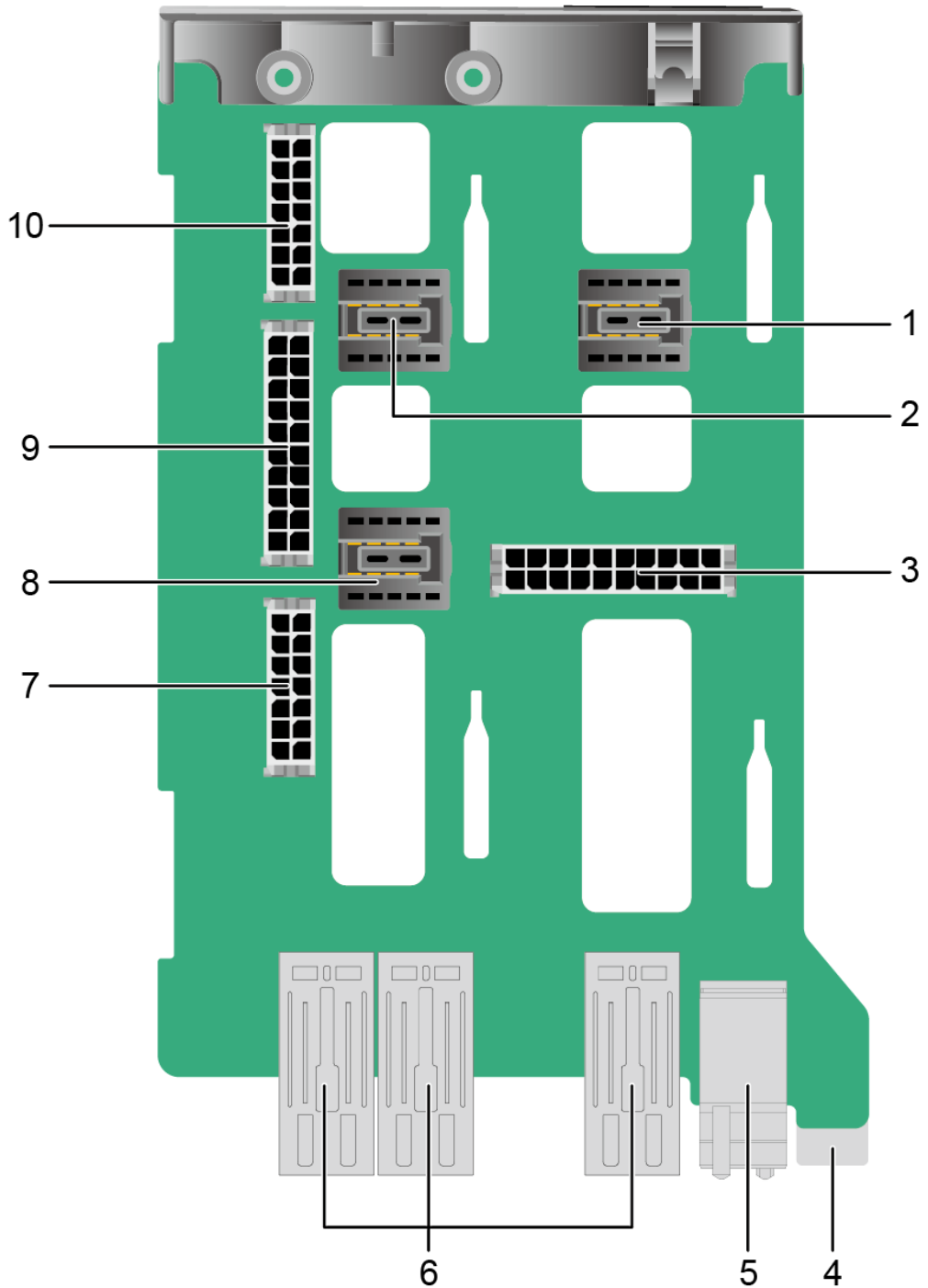

1	Drive backplane 1 power connector (BP-1/J16)	2	Fan board power connector (FAN-1/J14)
3	I/O module 5 power connector (Riser5/J10)	4	Guide sleeve

5	Power board signal connector (J1)	6	Mainboard power connector (J4/J5/J6)
7	Fan board power connector 2 (J11)	8	Drive backplane 2 power connector (BP-2/J15)
9	I/O module 3 power connector (Riser3/J12)	10	I/O module 4 power connector (Riser4/J13)

5.11.4 Fan Board

Figure 5-67 Fan board 1

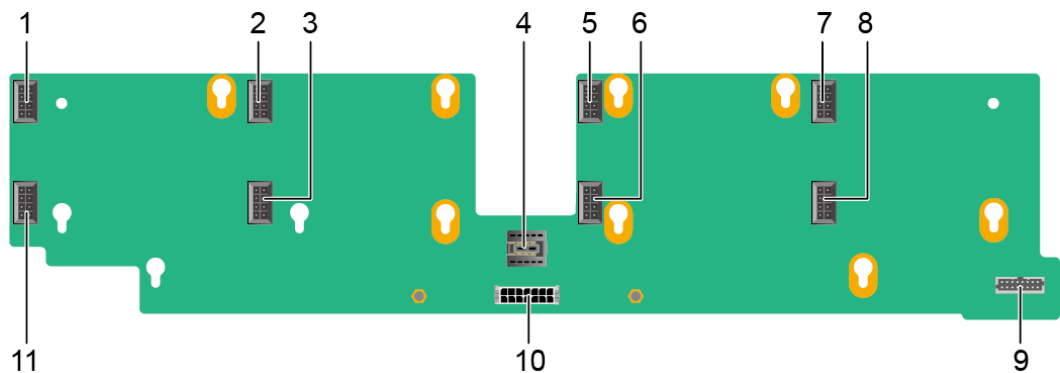

1	Fan connector (FAN1B/J7)	2	Fan connector (FAN2B/J8)
3	Fan connector (FAN2A/J6)	4	Fan board power connector 1 (POWER CONN1/J4)
5	Fan connector (FAN3B/J11)	6	Fan connector (FAN3A/J9)
7	Fan connector (FAN4B/J12)	8	Fan connector (FAN4A/J10)
9	Fan board signal connector (MISC CONN/J3)	10	Fan board power connector 2 (POWER CONN2/J2)
11	Fan connector (FAN1A /J5)	-	-

5.11.5 M.2 SSD Adapter Board

Figure 5-68 M.2 SSD adapter board

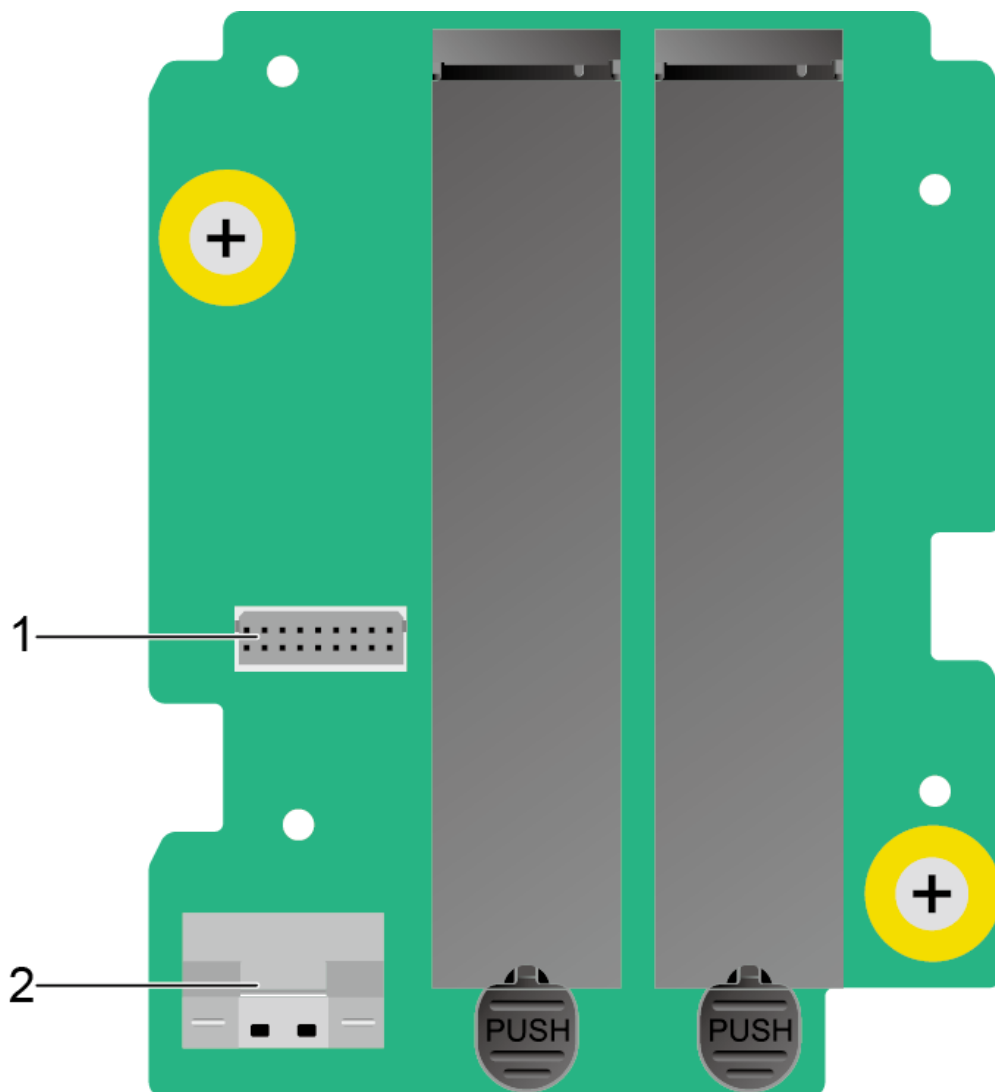

1	Signal connector (M. 2CONN/J1)	2	High-speed connector (Slimline X8/J2)
---	--------------------------------	---	---------------------------------------

6 Product Specifications

[6.1 Technical Specifications](#)

[6.2 Environmental Specifications](#)

[6.3 Physical Specifications](#)

6.1 Technical Specifications

Table 6-1 Technical specifications

Category	Specifications
Form factor	4U rack server
Chipset	Emmitsburg PCH
Processor	<p>Supports two or four processors.</p> <ul style="list-style-type: none"> • New-generation Intel® Xeon® Scalable processors (Sapphire Rapids) • Built-in memory controller and eight memory channels per processor. • Built-in PCIe controller, supporting PCIe 5.0 and 80 lanes per processor. • Three UPI buses between processors, providing up to 16 GT/s transmission per channel • Up to 60 cores • Max. 4.2 GHz turbo frequency. • Min. 1.875 MB L3 cache per core • Max. 350 W thermal design power (TDP). <p>NOTE The preceding information is for reference only. For details, see "Search Parts" in the compatibility list on the technical support website.</p>

Category	Specifications
Memory	<p>64 memory slots.</p> <ul style="list-style-type: none">● Up to 64 DDR5 DIMMs<ul style="list-style-type: none">– RDIMM or RDIMM-3DS support.– Max. 4800 MT/s memory speed– DDR5 memory modules of different types (RDIMM and RDIMM-3DS) and specifications (capacity, bit width, rank, and height) cannot be used together.– A server must use DDR5 DIMMs of the same P/N code. <p>NOTE The preceding information is for reference only. For details, see "Search Parts" in the compatibility list on the technical support website.</p>

Category	Specifications
Storage	<p>Supports a variety of drive configurations. For details, see 5.5.1 Drive Configuration and Drive Numbering.</p> <ul style="list-style-type: none"> ● Supports two M.2 SSDs. <ul style="list-style-type: none"> – VROC (SATA RAID) can be configured for the M.2 SSDs when the server is configured with an M.2 SSD adapter card. <p>NOTE</p> <ul style="list-style-type: none"> ● The M.2 SSD is used only as a boot device for installing the OS. Small-capacity (32 GB or 64 GB) M.2 SSDs do not support logging due to poor endurance. If a small-capacity M.2 SSD is used as the Boot device, a dedicated log drive or log server is required for logging. For example, you can dump VMware logs in either of the following ways: <ul style="list-style-type: none"> ● Redirect <code>/scratch</code>. For details, see https://kb.vmware.com/s/article/1033696. ● Configure syslog. For details, see https://kb.vmware.com/s/article/2003322. ● The M.2 SSD cannot be used to store service data due to poor endurance. In write-intensive applications, the M.2 SSD will wear out in a short time. If you want to use SSDs or HDDs as data storage devices, use enterprise-level SSDs or HDDs with high DWPD. ● The M.2 SSD is not recommended for write-intensive service software due to poor endurance. ● Do not use M.2 SSDs for cache. <ul style="list-style-type: none"> ● Supports hot swap of SAS/SATA/NVMe U.2 drives. <p>NOTE</p> <p>When NVMe drives are configured:</p> <ul style="list-style-type: none"> ● Before using the VMD function, contact technical support engineers of the OS vendor to check whether the OS supports the VMD function. If yes, check whether the VMD driver needs to be manually installed and check the installation method. ● When the VMD function is enabled and the latest VMD driver is installed, surprise hot swap is supported. ● When the VMD function is disabled, orderly hot swap is supported. <ul style="list-style-type: none"> ● Support a variety of RAID controller cards. For details, see "Search Parts" in the Compatibility List on the support website. <ul style="list-style-type: none"> – The RAID controller card supports RAID configuration, RAID level migration, and drive roaming. – The RAID controller card supports a supercapacitor for power-off protection to ensure user data security. – The PCIe RAID controller card occupies one PCIe slot.

Category	Specifications
	<ul style="list-style-type: none"> – The RAID controller card supports Intel VROC (VMD NVMe RAID) for RAID management of NVMe drives. Different VROC keys can be configured to support multiple RAID levels. <p>For details about the RAID controller card, see the server <i>RAID Controller Card User Guide</i>.</p> <p>NOTE If the BIOS is in legacy mode, the 4K drive cannot be used as the boot drive.</p>
Network	<p>OCP 3.0 NICs provide network expansion capabilities.</p> <ul style="list-style-type: none"> ● Supports one OCP 3.0 NIC. ● Supports orderly hot swap. <p>NOTE The OCP 3.0 NIC supports orderly hot swap only when the VMD function is disabled.</p> <ul style="list-style-type: none"> ● Supports a variety of OCP 3.0 NICs. For details, visit the technical support website and see Search Parts in the compatibility list.
I/O expansion	<p>Supports 22 PCIe slots.</p> <ul style="list-style-type: none"> ● Supports one PCIe slot dedicated for OCP 3.0 NICs and 21 standard PCIe slots. <p>For details, see 5.7.2 PCIe Slots and 5.7.3 PCIe Slot Description.</p> <p>NOTE The preceding information is for reference only. For details, see "Search Parts" in the compatibility list on the technical support website.</p>
Port	<p>Supports a variety of ports.</p> <ul style="list-style-type: none"> ● Ports on the front panel: <ul style="list-style-type: none"> – One USB Type-C iBMC direct connect management port – Two USB 3.0 ports – One DB15 VGA port ● Ports on the rear panel: <ul style="list-style-type: none"> – Two USB 3.0 ports – One DB15 VGA port – One RJ45 serial port – One RJ45 management network port ● Built-in ports: <ul style="list-style-type: none"> – One USB 2.0 port – Two SATA ports <p>NOTE You are not advised to install the OS on the USB storage media.</p>

Category	Specifications
Video card	<p>An SM750 video chip with 32 MB display memory is integrated on the mainboard. The maximum display resolution is 1920 x 1200 at 60 Hz with 16M colors.</p> <p>NOTE</p> <ul style="list-style-type: none"> • The integrated video card can provide the maximum display resolution (1920 x 1200) only after the video card driver matching the operating system version is installed. Otherwise, only the default resolution supported by the operating system is provided. • If both the front and rear VGA ports are connected to monitors, only the monitor connected to the front VGA port displays information.
System management	<ul style="list-style-type: none"> • UEFI • iBMC • NC-SI • Integration with third-party management systems • Integration with FusionDirector
Security feature	<ul style="list-style-type: none"> • Power-on password • Administrator password • TPM (for China and outside China)/TCM (only for China) • Secure boot • Front bezel (optional) • Chassis cover opening detection

6.2 Environmental Specifications

Table 6-2 Environmental specifications

Category	Specifications
Temperature	<ul style="list-style-type: none"> ● Operating temperature: 5°C to 45°C (41°F to 113°F) (ASHRAE Classes A1 to A4 compliant) ● Storage temperature (within three months): -30°C to +60°C (-22°F to +140°F) ● Storage temperature (within six months): -15°C to +45°C (5°F to 113°F) ● Storage temperature (within one year): -10°C to +35°C (14°F to 95°F) ● Maximum temperature change rate: 20°C (36°F) per hour and 5°C (9°F) per 15 minutes <p>NOTE The highest operating temperature varies depending on the server configuration. For details, see A.3 Operating Temperature Limitations.</p>
Relative humidity (RH, non-condensing)	<ul style="list-style-type: none"> ● Operating humidity: 8% to 90% ● Storage humidity (within three months): 8% to 85% ● Storage humidity (within six months): 8% to 80% ● Storage humidity (within one year): 20% to 75% ● Maximum change humidity rate: 20% per hour ● Operational climatic range category 8% RH with -12°C (10.4°F) minimum dew point to 90% RH with 24°C (75.2°F) maximum dew point (ASHRAE Classes A4 compliant)
Air volume	≥ 96 CFM

Category	Specifications
Operating altitude	<p>≤ 3050 m (10,006.56 ft)</p> <ul style="list-style-type: none"> ● When the server configuration complies with ASHRAE Classes A1 and A2 and the altitude is above 900 m (2952.76 ft), the highest operating temperature decreases by 1°C (1.8°F) for every increase of 300 m (984.25 ft). ● When the server configuration complies with ASHRAE Class A3 and the altitude is above 900 m (2952.76 ft), the highest operating temperature decreases by 1°C (1.8°F) for every increase of 175 m (574.15 ft). ● When the server configuration complies with ASHRAE Class A4 and the altitude is above 900 m (2952.76 ft), the highest operating temperature decreases by 1°C (1.8°F) for every increase of 125 m (410.10 ft). ● HDDs cannot be used at an altitude of over 3050 m (10,006.56 ft).
Corrosive gaseous contaminant	<p>Maximum growth rate of the corrosion product thickness:</p> <ul style="list-style-type: none"> ● Copper corrosion rate test: 300 Å/month (meeting level G1 requirements of the ANSI/ISA-71.04-2013 standard on gaseous corrosion) ● Silver corrosion rate test: 200 Å/month
Particle contaminant	<ul style="list-style-type: none"> ● Meets the requirements of ISO 14664-1 Class 8. ● There is no explosive, conductive, magnetic, or corrosive dust in the equipment room. <p>NOTE It is recommended that the particulate pollution in the equipment room be monitored by a professional agency.</p>
Acoustic noise	<p>The declared A-weighted sound power levels (LWAd) and declared average bystander position A-weighted sound pressure levels (LpAm) listed are measured at 23°C (73.4°F) in accordance with ISO 7779 (ECMA 74) and declared in accordance with ISO 9296 (ECMA 109).</p> <ul style="list-style-type: none"> ● Idle: <ul style="list-style-type: none"> – LWAd: 5.73 Bels – LpAm: 40.2 dBA ● Operating: <ul style="list-style-type: none"> – LWAd: 6.62 Bels – LpAm: 49.1 dBA <p>NOTE Actual sound levels generated during operation vary depending on the configuration, load, and ambient temperature.</p>

 **NOTE**

SSDs and HDDs (including NL-SAS, SAS, and SATA) cannot be preserved for a long time in the power-off state. Data may be lost or faults may occur if the preservation duration exceeds the specified maximum duration. When drives are preserved under the storage temperature and humidity specified in the preceding table, the following preservation duration is recommended:

- Maximum preservation duration of SSDs:
 - 12 months in power-off state without data stored
 - 3 months in power-off state with data stored
- Maximum preservation duration of HDDs:
 - 6 months in unpacked/packed and powered-off state
- The maximum preservation duration is determined according to the preservation specifications provided by drive vendors. For details, see the manuals provided by drive vendors.

6.3 Physical Specifications

Table 6-3 Physical specifications

Category	Description
Dimensions (H x W x D)	175 mm × 447 mm × 900 mm (6.89 in. x 17.60 in. x 35.43 in.)
Installation space	<ul style="list-style-type: none"> • Requirements for cabinet installation: <ul style="list-style-type: none"> – Cabinet compliant with the International Electrotechnical Commission (IEC) 297 standard – Cabinet width: 447 mm (17.60 in.) – Cabinet depth ≥ 1100 mm (43.31 in.) • Requirements for guide rails installation: <ul style="list-style-type: none"> – L-shaped guide rails: apply only to xFusion cabinets. – Adjustable L-shaped guide rails: apply to cabinets with a distance of 590 mm to 900 mm (23.23 in. to 35.43 in.) between the front and rear mounting bars. – Ball bearing rail kit: applies to cabinets with a distance of 609 mm to 914 mm (23.98 in. to 35.98 in.) between the front and rear mounting bars. <p>NOTE For a 1100 mm (43.31 in.) deep cabinet, a distance of 70 mm to 110 mm (2.76 in. to 4.33 in.) between the front mounting bar and the front cabinet door is recommended.</p>

Category	Description
Weight in full configuration	<ul style="list-style-type: none"> ● Net weight: <ul style="list-style-type: none"> – Maximum weight of a server with 8 x 2.5" front drives and four GPU cards: 52.3 kg (115.30 lb) – Maximum weight for server with 12 x 2.5" front drives: 48.1 kg (106.04 lb) – Maximum weight for server with 24 x 2.5" front drives: 51 kg (112.44 lb) – Maximum weight for server with 25 x 2.5" front drives: 51.25 kg (112.99 lb) – Maximum weight of a server with 50 x 2.5" front drives: 57.3 kg (126.32 lb) ● Packaging materials: 23.4 kg (51.59 lb)
Power consumption	The power consumption parameters vary with hardware configurations (including the configurations complying with EU ErP). For details, see Power Calculator on the technical support website.

7 Software and Hardware Compatibility

For details about the OS and hardware, see the compatibility list on the technical support website.

NOTICE

- If incompatible components are used, the device may be abnormal. Such a fault is beyond the scope of technical support and warranty.
 - The performance of servers is closely related to application software, basic middleware software, and hardware. The slight differences of the application software, middleware basic software, and hardware may cause performance inconsistency between the application layer and test software layer.
 - If the customer has requirements on the performance of specific application software, contact technical support to apply for proof of concept (POC) tests in the pre-sales phase to determine detailed software and hardware configurations.
 - If the customer has requirements on hardware performance consistency, specify the specific configuration requirements (for example, specific drive models, RAID controller cards, or firmware versions) in the presales phase.
-

8 Safety Instructions

[8.1 Security](#)

[8.2 Maintenance and Warranty](#)

8.1 Security

General Statement

- Comply with local laws and regulations when installing equipment. These safety instructions are only a supplement.
- Observe the safety instructions that accompany all "DANGER", "WARNING", and "CAUTION" symbols in this document.
- Observe all safety instructions provided on device labels.
- Operators of special types of work (such as electricians, operators of electric forklifts, and so on.) must be certified or authorized by the local government or authority.



In a household scenario, operation of this device may cause radio interference.

Human Safety

- This device is not suitable for use in places where children may be present.
- Only certified or authorized personnel are allowed to install equipment.
- Discontinue any dangerous operations and take protective measures. Report anything that could cause personal injury or device damage to a project supervisor.
- Do not move devices or install cabinets and power cables in hazardous weather conditions.
- Do not carry the weight that exceeds the maximum load per person allowed by local laws or regulations. Before moving a device, check the maximum device weight and arrange required personnel.

- Wear clean protective gloves, ESD clothing, a protective hat, and protective shoes, as shown in **Figure 8-1**.

Figure 8-1 Safety work wear

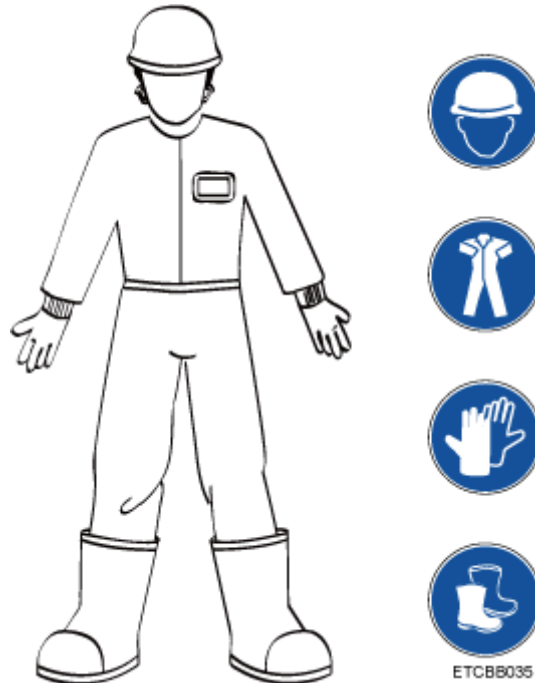

- Before touching a device, wear ESD clothing and gloves (or wrist strap), and remove any conductive objects (such as watches and jewelry). **Figure 8-2** shows conductive objects that must be removed before you touch a device.

Figure 8-2 Removing conductive objects



Figure 8-3 shows how to wear an ESD wrist strap.

- a. Secure the ESD wrist strap around your wrist.
- b. Fasten the strap buckle and ensure that the ESD wrist strap is in contact with your skin.
- c. Insert the ground terminal attached to the ESD wrist strap into the jack on the grounded cabinet or chassis.

Figure 8-3 Wearing an ESD wrist strap

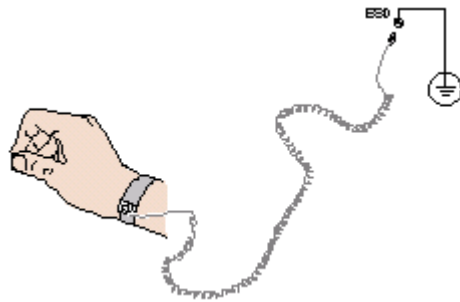

- Exercise caution when using tools that could cause personal injury.
- If the installation position of a device is higher than the shoulders of the installation personnel, use a vehicle such as a lift to facilitate installation. Prevent the device from falling down and causing personal injury or damage to the device.
- The equipment is powered by high-voltage power sources. Direct or indirect contact (especially through damp objects) with high-voltage power sources may result in serious injury or death.
- Ground a device before powering it on. Otherwise, high voltage leakage current may cause personal injury.
- When a ladder is used, ensure that another person holds the ladder steady to prevent accidents.
- Do not look into optical ports without eye protection when installing, testing, or replacing optical cables.

Equipment Safety

- Use the recommended power cables at all times.
- Power cables are used only for dedicated servers. Do not use them for other devices.
- Before operating equipment, wear ESD clothes and gloves to prevent electrostatic-sensitive devices from being damaged by ESD.
- When moving a device, hold the bottom of the device. Do not hold the handles of the installed modules, such as the PSUs, fan modules, drives, and the mainboard. Handle the equipment with care.
- Exercise caution when using tools that could cause damage to devices.
- Connect the primary and secondary power cables to different power distribution units (PDUs) to ensure reliable system operation.
- Ground a device before powering it on. Otherwise, high voltage leakage current may cause device damage.

Transportation Precautions

Improper transportation may damage equipment. Contact the manufacturer for precautions before attempting transportation.

Transportation precautions include but are not limited to:

- The logistics company engaged to transport the device must be reliable and comply with international standards for transporting electronics. Ensure that the

equipment being transported is always kept upright. Take necessary precautions to prevent collisions, corrosion, package damage, damp conditions and pollution.

- Transport each device in its original packaging.
- If the original packaging is unavailable, package heavy, bulky parts (such as chassis and blades) and fragile parts (such as PCIe cards and optical modules) separately.

 NOTE

For details about components supported by the server, see "Search Parts" in the compatibility list on the technical support website.

- Power off all devices before transportation.

Maximum Weight Carried by a Person

 CAUTION

The maximum weight allowed to be carried by a single person is subject to local laws or regulations. The markings on the device and the descriptions in the documentation are for reference only.

Table 8-1 lists the maximum weight one person is permitted to carry as stipulated by a number of organizations.

Table 8-1 Maximum weight carried per person

Organization	Weight (kg/lb)
European Committee for Standardization (CEN)	25/55.13
International Organization for Standardization (ISO)	25/55.13
National Institute for Occupational Safety and Health (NIOSH)	23/50.72
Health and Safety Executive (HSE)	25/55.13
General Administration of Quality Supervision, Inspection and Quarantine of the People's Republic of China (AQSIQ)	<ul style="list-style-type: none"> • Male: 15/33.08 • Female: 10/22.05

For more information about security instructions, see the server *Safety Information*.

8.2 Maintenance and Warranty

For details about maintenance, visit the **Technical Support Website > Service Support Center > Customer Support Service**.

For details about warranty, visit the **Technical Support Website > Service Support Center > Warranty**.

9 System Management

This product integrates the new-generation Intelligent Baseboard Management Controller (iBMC), which complies with Intelligent Platform Management Interface 2.0 (IPMI 2.0) specifications and provides reliable hardware monitoring and management.

The iBMC intelligent management system has the following features:

- Various management interfaces.
The iBMC provides the following standard interfaces to meet various system integration requirements:
 - DCMI 1.5 interface
 - IPMI 1.5/IPMI 2.0 interface
 - Command-line interface
 - Redfish interface
 - Hypertext Transfer Protocol Secure (HTTPS) interface
 - Simple Network Management Protocol (SNMP) interface
- Fault monitoring and diagnosis
The iBMC detects hidden risks and ensures stable, uninterrupted 24/7 system operation by providing the following features:
 - The last screenshot and video recording function when the system crashes makes it impossible to analyze the cause of the system crash.
 - Screen snapshots and screen recordings make scheduled inspection, operation recording, and audit easy.
 - The fault diagnosis & management (FDM) function supports component-based precise fault diagnosis, facilitating component fault locating and replacement.
 - The iBMC supports the reporting of alarms through syslog packets, trap packets, and emails, helping the upper-layer NMS platform to collect the fault information about the server.
 - If the server is configured with the LCD module, the LCD can directly obtain device information from the iBMC.
- Security management methods

- Software image backup improves system security. Even if the running software completely breaks down, the system can be started from the backup image.
- Diversified user security control interfaces are provided to ensure user login security.
- Multiple certificates can be imported and replaced to ensure data transmission security.
- System maintenance interface
 - Supports virtual keyboard, video, and mouse (KVM) and virtual media functions to facilitate remote maintenance.
 - Supports out-of-band RAID monitoring and configuration to improve RAID configuration efficiency and management capabilities.
 - Smart Provisioning implements DVD-free OS installation, RAID configuration, and upgrades to simplify server installation and configuration.
- Diversified network protocols
 - Supports NTP to improve the device time configuration capability and synchronizes the network time.
 - Supports domain management and directory services to simplify the server management network.
- Intelligent power management
 - Power capping technology makes it easy to increase deployment density.
 - Dynamic energy saving helps reduce the operating expense (OPEX).
- License management
 - License management allows advanced features to be used by authorized users. The advanced edition of the iBMC provides the following features:
 - Use Redfish to deploy the OS.
 - Use Redfish to collect raw data for intelligent diagnosis.

10 Certifications

Country/Region	Certification	Standard
China	CCC	GB 17625.1-2022 GB 4943.1-2022 GB/T 9254.1-2021 (Class A)
China	RoHS	SJ/T 11364 GB/T 26572
Europe	WEEE	2012/19/EU
Europe	REACH	EC NO.1907/2006
Europe	CE	Safety: EN 62368-1:2014+A11:2017 EMC: EN 55032:2015+A1:2020 EN IEC 61000-3-2:2019+A1:2021 EN 61000-3-3:2013+A1:2019 EN 55035:2017+A11:2020 CISPR 35:2016 EN 55024:2010+A1:2015 CISPR 24:2010+A1:2015 ETSI EN 300 386 V1.6.1:2012 ETSI EN 300 386 V2.1.1:2016 RoHS: EN IEC 63000:2018 ErP: Commission Regulation(EU) NO. 2019/424

Country/Region	Certification	Standard
UK	UKCA	Safety: EN 62368-1:2014+A11:2017 EMC: EN 55032:2015+A11:2020 EN IEC 61000-3-2:2019+A1:2021 EN 61000-3-3:2013+A1:2019 EN 55035:2017+A11:2020 CISPR 35:2016 EN 55024:2010+A1:2015 CISPR 24:2010+A1:2015 ETSI EN 300 386 V1.6.1:2012 ETSI EN 300 386 V2.1.1:2016 RoHS: BS EN IEC 63000:2018 ErP: Commission Regulation(EU) NO. 2019/424
Japan	VCCI	VCCI 32-1
North America	NRTL	UL 62368-1:2019 CSA C22.2 NO.62368-1:19
Canada	IC	ICES-003
US	FCC	FCC PART 15
Russia	EAC&GOST	GOCT CISPR 32-2015 GOCT CISPR 24-2013 GOCT IEC 61000-3-2-2017 GOCT IEC 61000-3-3-2015 GOCT IEC 62368-1-2014 GOCT IEC 62479-2013
Global	CB	IEC 62368-1:2014 IEC 62368-1:2018

11 Waste Product Recycling

To obtain the product recycling service from xFusion after products are scrapped, contact 400-009-8999 for technical support.

A Appendix

A.1 Chassis Label Information

A.1.1 Chassis Head Label

Figure A-1 Chassis head label

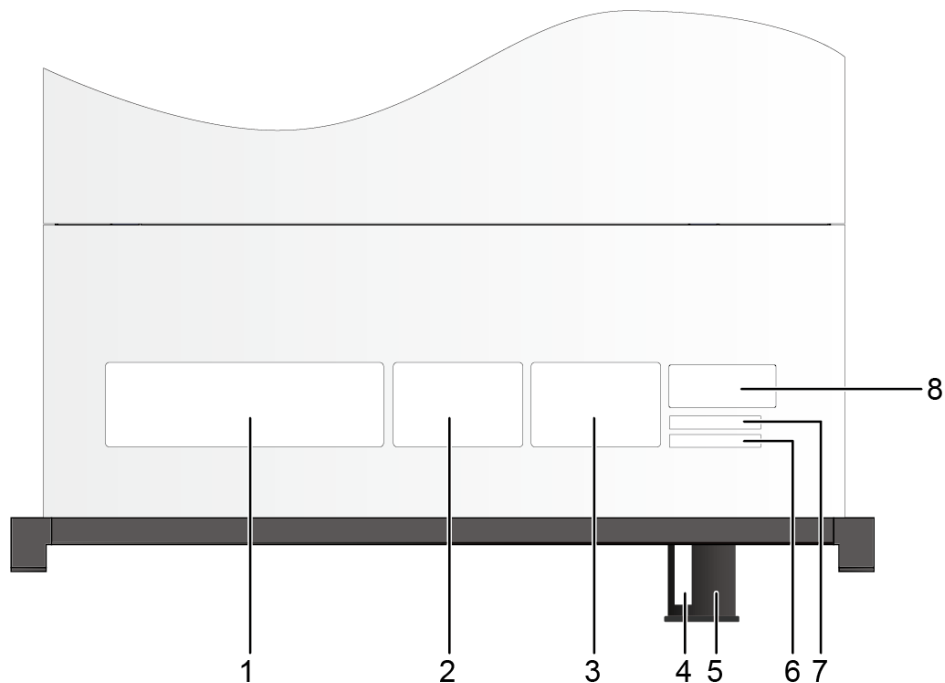

1	Nameplate	2	Certificate
3	Quick access tag	4	Product SN NOTE For details, see Product SN .

5	Slide-out label plate NOTE The location of the slide-out label plate varies depending on the server model or configuration. For details, see 5.1.1 Appearance .	6	Product SN NOTE For details, see Product SN .
7	Reserved space for customized label	8	Pressure-proof label NOTE This label warns users not to place any objects on top of a rack-mounted device.

A.1.1.1 Nameplate

Figure A-2 Nameplate example

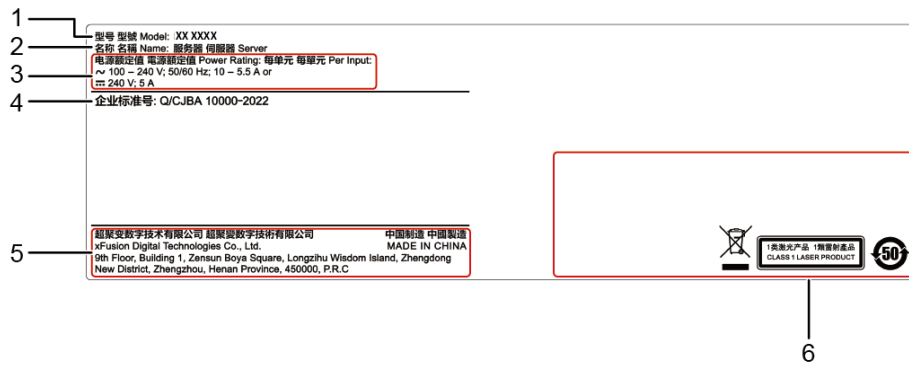

Table A-1 Nameplate description

No.	Description
1	Server model NOTE For details, see A.4 Nameplate .
2	Device name
3	Power supply requirements
4	Enterprise standard number
5	Vendor information
6	Certification marks

A.1.1.2 Certificate

Figure A-3 Certificate example



Table A-2 Certificate description

No.	Description
1	Order
2	No. NOTE For details, see Figure A-4 and Table A-3 .
3	QC inspector
4	Production date
5	No. barcode

Figure A-4 Certificate number example



Table A-3 Certificate number description

No.	Description
1	P : a fixed value for this digit
2	Z : a fixed value for this digit
3	<ul style="list-style-type: none"> ● Y: a server ● B: a semi-finished server ● N: a spare part

No.	Description
4	0 : a value for the reserved digit
5	Year (two characters)
6	Month (one character) <ul style="list-style-type: none"> • Digits 1 to 9 indicate January to September respectively. • Letters A to C indicate October to December respectively.
7	Day (one character) <ul style="list-style-type: none"> • Digits 1 to 9 indicate the 1st to 9th. • Letters A to H indicate the 10th to 17th. • Letters J to N indicate the 18th to 22nd. • Letters P to Y indicate the 23rd to 31st.
8	Hour (one character) <ul style="list-style-type: none"> • Digits 0 to 9 indicate 0:00 to 9:00. • Letters A to H indicate 10:00 to 17:00. • Letters J to N indicate 18:00 to 22:00. • Letters P to Q indicate 23:00 to 24:00.
9	Serial number (two characters)
10	Manufacturing serial number (five characters)

A.1.1.3 Quick Access Label

Figure A-5 Quick access label example

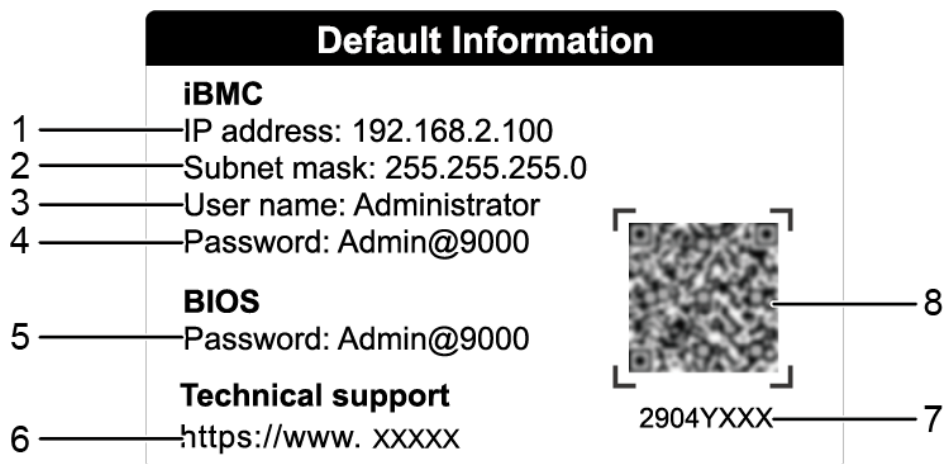
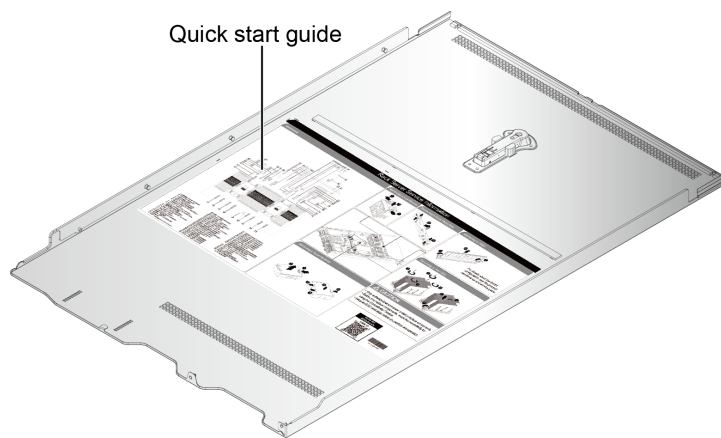

Table A-4 Quick access label description

No.	Description
1	IP address of the iBMC management network port
2	Subnet mask of the iBMC management network port
3	Default iBMC user name
4	Default iBMC password
5	Default BIOS password
6	Technical support website
7	P/N code
8	QR code NOTE Scan the QR code to obtain technical support resources.

A.1.2 Chassis Internal Label

Figure A-6 Chassis internal label



NOTE

- The quick start guide is located on the inside of the chassis cover. It describes how to remove the mainboard components, important components of the chassis, precautions, and QR codes of technical resources. The pictures are for reference only. For details, see the actual product.
- The quick start guide is optional. For details, see the actual product.

A.1.3 Chassis Tail Label

Figure A-7 Chassis tail label

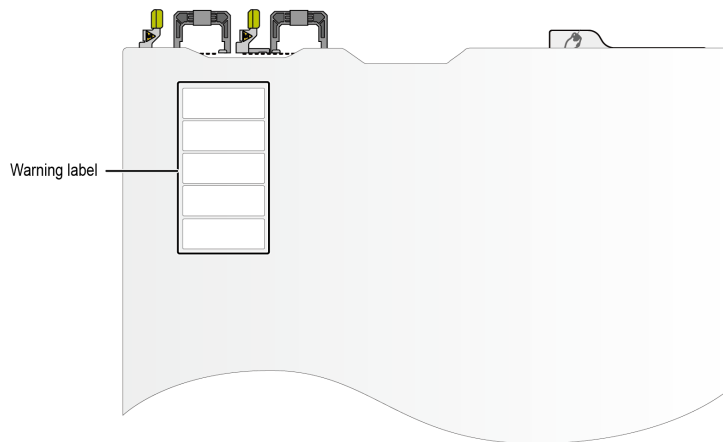

NOTE

For details about the warning label, see the server *Safety Information*.

A.2 Product SN

The serial number (SN) on the label plate uniquely identifies a server. The SN is required when users contact xFusion technical support. SNs can be in three forms, as shown in [SN Sample 1](#), [SN Sample 2](#), and [SN Sample 3](#).

- SN example 1

Figure A-8 SN example 1



Table A-5 SN description

No.	Description
1	SN ID (two characters), which is 21 .
2	Material identification code (eight characters), that is, the processing code.
3	Vendor code (two characters), that is, the code of the processing place.

No.	Description
4	Year and month (two characters) <ul style="list-style-type: none"> The first character indicates the year. <ul style="list-style-type: none"> Digits 1 to 9 indicate years 2001 to 2009 respectively. Letters A to H indicate years 2010 to 2017 respectively. Letters J to N indicate years 2018 to 2022 respectively. Letters P to Y indicate years 2023 to 2032 respectively. <p>NOTE The years from 2010 are represented by upper-case letters excluding I, O, and Z because the three letters are similar to the digits 1, 0, and 2.</p> <ul style="list-style-type: none"> The second character indicates the month. <ul style="list-style-type: none"> Digits 1 to 9 indicate January to September respectively. Letters A to C indicate October to December respectively.
5	Serial number (six characters)
6	RoHS compliance status (one character). Y indicates RoHS compliant.
7	Internal model, that is, product name.

- SN example 2

Figure A-9 SN example 2



Table A-6 SN example 2

No.	Description
1	SN ID (two characters), which is 21 .
2	Material identification code (eight characters), that is, the processing code.
3	Vendor code (two characters), that is, the code of the processing place.

No.	Description
4	Year and month (two characters) <ul style="list-style-type: none"> The first character indicates the year. <ul style="list-style-type: none"> Digits 1 to 9 indicate years 2001 to 2009 respectively. Letters A to H indicate years 2010 to 2017 respectively. Letters J to N indicate years 2018 to 2022 respectively. Letters P to Y indicate years 2023 to 2032 respectively. <p>NOTE The years from 2010 are represented by upper-case letters excluding I, O, and Z because the three letters are similar to the digits 1, 0, and 2.</p> <ul style="list-style-type: none"> The second character indicates the month. <ul style="list-style-type: none"> Digits 1 to 9 indicate January to September respectively. Letters A to C indicate October to December respectively.
5	Serial number (six characters)
6	RoHS compliance status (one character). Y indicates RoHS compliant.
7	Nameplate (six characters).
8	Serial number. The number of digits depends on the actual product.

- SN example 3

Figure A-10 Label example



Table A-7 Label example description

No.	Description
1	QR code. For details, see Figure A-12 .
2	BOM code (10 digits).
3	Product model (13 characters).
4	Product SN (12 characters). For details, see Table A-8 .
5	RoHS compliance code (one character).

Figure A-11 SN example

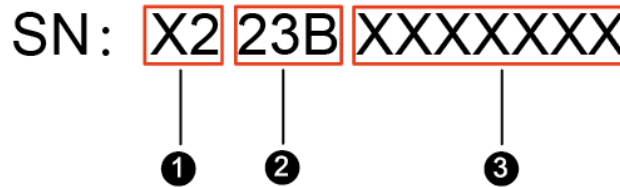

Table A-8 SN description

No.	Description
1	Manufacturer code (two characters).
2	Year and month (three characters). <ul style="list-style-type: none"> The first and second characters indicate the year. NOTE A four-digit year is indicated by the last two digits of the year. For example, 23 indicates the year 2023. <ul style="list-style-type: none"> The third character indicates the month. <ul style="list-style-type: none"> Digits 1 to 9 indicate January to September respectively. Letters A to C indicate October to December respectively.
3	Serial number (seven characters).

Figure A-12 QR code scanning result example

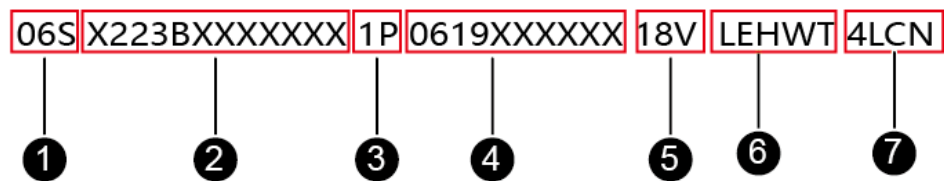

Table A-9 QR code scanning result example description

No.	Description
1	Fixed representation symbol (three characters).
2	Product SN (12 characters). For details, see Table A-8 .
3	Data identifier for the material code (two characters).
4	BOM code (10 digits).

No.	Description
5	Data identifier of manufacturer (three characters).
6	Code of device manufacturer (five characters).
7	Data identifier of origin (four characters).

A.3 Operating Temperature Limitations

Table A-10 Operating temperature limitations

Configuration	Maximum Operating Temperature 30°C (86°F)	Maximum Operating Temperature 35°C (95°F)	Maximum Operating Temperature 40°C (104°F)	Maximum Operating Temperature 45°C (113°F)
8 x 2.5" drive pass-through configuration	<ul style="list-style-type: none"> All configurations are supported with 270 W or lower TDP processors ^a. When processors ^b with TDP higher than 270 W and GPU cards are configured, 100 Gbit/s or 200 Gbit/s NICs or OCP 3.0 NICs of 100 Gbit/s or higher are not supported. 	<ul style="list-style-type: none"> All configurations are supported with 270 W or lower TDP processors ^a. When processors ^b with TDP higher than 270 W and GPU cards are configured, 100 Gbit/s or 200 Gbit/s NICs or OCP 3.0 NICs of 100 Gbit/s or higher are not supported. A40 GPU cards are not supported. 	<ul style="list-style-type: none"> Processors ^b with TDP higher than 270 W are not supported. Memory modules whose capacity is 128 GB per module or larger are not supported. OCP 3.0 NICs whose rate equals to or greater than 100 Gbit/s are not supported. GPU cards are not supported. 100 Gbit/s or 200 Gbit/s NICs can be configured only on I/O module 3, I/O module 4, or I/O module 5. 	<ul style="list-style-type: none"> Processors ^b with TDP higher than 270 W are not supported. Memory modules whose capacity is 128 GB per module or larger are not supported. OCP 3.0 NICs whose rate equals to or greater than 100 Gbit/s are not supported. GPU cards are not supported. NICs whose rate is 100 Gbit/s or 200 Gbit/s are not supported.

Configuration	Maximum Operating Temperature 30°C (86°F)	Maximum Operating Temperature 35°C (95°F)	Maximum Operating Temperature 40°C (104°F)	Maximum Operating Temperature 45°C (113°F)
12 x 2.5" drive pass-through configuration	<ul style="list-style-type: none"> • All configurations are supported with 270 W or lower TDP processors ^a. • When processors ^b with TDP higher than 270 W are configured, the GPU card does not support 100GE/200GE NICs or OCP 3.0 NICs of 100 Gbit/s or higher. 	<ul style="list-style-type: none"> • All configurations are supported with 270 W or lower TDP processors ^a. • When processors ^b with TDP higher than 270 W are configured, the GPU card does not support 100GE/200GE NICs or OCP 3.0 NICs of 100 Gbit/s or higher. • A40 GPU cards are not supported. 	<ul style="list-style-type: none"> • Processors ^b with TDP higher than 270 W are not supported. • Memory modules whose capacity is 128 GB per module or larger are not supported. • OCP 3.0 NICs whose rate is 100 Gbit/s are not supported. • GPU cards are not supported. • 100 Gbit/s or 200 Gbit/s NICs can be configured only on I/O module 3, I/O module 4, or I/O module 5. 	<ul style="list-style-type: none"> • Not supported.

Configuration	Maximum Operating Temperature 30°C (86°F)	Maximum Operating Temperature 35°C (95°F)	Maximum Operating Temperature 40°C (104°F)	Maximum Operating Temperature 45°C (113°F)
24 x 2.5" drive SAS pass-through configuration	<ul style="list-style-type: none"> • All configurations are supported with 270 W or lower TDP processors^a. • When processors^b with TDP higher than 270 W are configured, the GPU card does not support 100GE/200GE NICs or OCP 3.0 NICs of 100 Gbit/s or higher. 	<ul style="list-style-type: none"> • All configurations are supported with 270 W or lower TDP processors^a. • When processors^b with TDP higher than 270 W are configured, the GPU card does not support 100GE/200GE NICs or OCP 3.0 NICs of 100 Gbit/s or higher. 	<ul style="list-style-type: none"> • Processors^b with TDP higher than 270 W are not supported. • Memory modules whose capacity is 128 GB per module or larger are not supported. • OCP 3.0 NICs whose rate is 100 Gbit/s are not supported. • GPU cards are not supported. • 100 Gbit/s or 200 Gbit/s NICs can be configured only on I/O module 3, I/O module 4, or I/O module 5. 	<ul style="list-style-type: none"> • Processors^b with TDP higher than 270 W are not supported. • Memory modules whose capacity is 128 GB per module or larger are not supported. • OCP 3.0 NICs whose rate is 100 Gbit/s are not supported. • GPU cards are not supported. • NICs whose rate is 100 Gbit/s or 200 Gbit/s are not supported.

Configuration	Maximum Operating Temperature 30°C (86°F)	Maximum Operating Temperature 35°C (95°F)	Maximum Operating Temperature 40°C (104°F)	Maximum Operating Temperature 45°C (113°F)
24 x 2.5" drive NVMe configuration	<ul style="list-style-type: none"> • All configurations are supported with 270 W or lower TDP processors^a. • When processors^b with TDP higher than 270 W are configured, the GPU card does not support 100 Gbit/s or 200 Gbit/s NICs or OCP 3.0 NICs of 100 Gbit/s or higher. 	<ul style="list-style-type: none"> • All configurations are supported with 270 W or lower TDP processors^a. • When processors^b with TDP higher than 270 W are configured, the GPU card does not support 100 Gbit/s or 200 Gbit/s NICs or OCP 3.0 NICs of 100 Gbit/s or higher. 	<ul style="list-style-type: none"> • Processors^b with TDP higher than 270 W are not supported. • Memory modules whose capacity is 128 GB per module or larger are not supported. • 100 Gbit/s or 200 Gbit/s NICs can be configured only on I/O module 3, I/O module 4, or I/O module 5. • OCP 3.0 NICs whose rate is 100 Gbit/s are not supported. • GPU cards are not supported. 	<ul style="list-style-type: none"> • Not supported.

Configuration	Maximum Operating Temperature 30°C (86°F)	Maximum Operating Temperature 35°C (95°F)	Maximum Operating Temperature 40°C (104°F)	Maximum Operating Temperature 45°C (113°F)
25 x 2.5" drive EXP configuration	<ul style="list-style-type: none"> • All configurations are supported with 270 W or lower TDP processors^a. • When processors^b with TDP higher than 270 W are configured, the GPU card does not support 100 Gbit/s or 200 Gbit/s NICs or OCP 3.0 NICs of 100 Gbit/s or higher. 	<ul style="list-style-type: none"> • All configurations are supported with 270 W or lower TDP processors^a. • When processors^b with TDP higher than 270 W are configured, the GPU card does not support 100 Gbit/s or 200 Gbit/s NICs or OCP 3.0 NICs of 100 Gbit/s or higher. 	<ul style="list-style-type: none"> • Processors^b with TDP higher than 270 W are not supported. • Memory modules whose capacity is 128 GB per module or larger are not supported. • OCP 3.0 NICs whose rate is 100 Gbit/s are not supported. • GPU cards are not supported. • 100 Gbit/s or 200 Gbit/s NICs can be configured only on I/O module 3, I/O module 4, or I/O module 5. 	<ul style="list-style-type: none"> • Processors^b with TDP higher than 270 W are not supported. • Memory modules whose capacity is 128 GB per module or larger are not supported. • OCP 3.0 NICs whose rate is 100 Gbit/s are not supported. • GPU cards are not supported. • NICs whose rate is 100 Gbit/s or 200 Gbit/s are not supported.

Configuration	Maximum Operating Temperature 30°C (86°F)	Maximum Operating Temperature 35°C (95°F)	Maximum Operating Temperature 40°C (104°F)	Maximum Operating Temperature 45°C (113°F)
50 x 2.5" drive EXP configuration	<ul style="list-style-type: none"> When 270 W or lower TDP processors^a are configured, 100 Gbit/s or 200 Gbit/s NICs can be configured only on I/O module 3, I/O module 4, or I/O module 5. OCP 3.0 NICs whose rate equals to or greater than 100 Gbit/s are not supported. When processors^b with TDP higher than 270 W are configured, NICs whose rate is 100 Gbit/s or 200 Gbit/s are not supported, and OCP 3.0 NICs whose rate equals to or greater than 100 Gbit/s are not supported. 	<ul style="list-style-type: none"> When 270 W or lower TDP processors^a are configured, 100 Gbit/s or 200 Gbit/s NICs can be configured only on I/O module 3, I/O module 4, or I/O module 5. OCP 3.0 NICs whose rate equals to or greater than 100 Gbit/s are not supported. When processors^b with TDP higher than 270 W are configured, NICs whose rate is 100 Gbit/s or 200 Gbit/s are not supported, and OCP 3.0 NICs whose rate equals to or greater than 100 Gbit/s are not supported. 	<ul style="list-style-type: none"> Not supported. 	<ul style="list-style-type: none"> Not supported.

Configuration	Maximum Operating Temperature 30°C (86°F)	Maximum Operating Temperature 35°C (95°F)	Maximum Operating Temperature 40°C (104°F)	Maximum Operating Temperature 45°C (113°F)
	<ul style="list-style-type: none">• Rear HDDs are not supported.	<ul style="list-style-type: none">• Rear HDDs are not supported.		

Configuration	Maximum Operating Temperature 30°C (86°F)	Maximum Operating Temperature 35°C (95°F)	Maximum Operating Temperature 40°C (104°F)	Maximum Operating Temperature 45°C (113°F)
49 x 2.5" Drive Configuration	<ul style="list-style-type: none"> • When 270 W or lower TDP processors^a are configured, 100 Gbit/s or 200 Gbit/s NICs can be configured only on I/O module 3, I/O module 4, or I/O module 5. OCP 3.0 NICs whose rate equals to or greater than 100 Gbit/s are not supported. • When processors^b with TDP higher than 270 W are configured, NICs whose rate is 100 Gbit/s or 200 Gbit/s are not supported, and OCP 3.0 NICs whose rate equals to or greater than 100 Gbit/s are not supported. 	<ul style="list-style-type: none"> • When 270 W or lower TDP processors^a are configured, 100 Gbit/s or 200 Gbit/s NICs can be configured only on I/O module 3, I/O module 4, or I/O module 5. OCP 3.0 NICs whose rate equals to or greater than 100 Gbit/s are not supported. • When processors^b with TDP higher than 270 W are configured, NICs whose rate is 100 Gbit/s or 200 Gbit/s are not supported, and OCP 3.0 NICs whose rate equals to or greater than 100 Gbit/s are not supported. 	<ul style="list-style-type: none"> • Not supported. 	<ul style="list-style-type: none"> • Not supported.

Configuration	Maximum Operating Temperature 30°C (86°F)	Maximum Operating Temperature 35°C (95°F)	Maximum Operating Temperature 40°C (104°F)	Maximum Operating Temperature 45°C (113°F)
a: Processor models with 270 W or lower TDP: 8454H/8450H/8444H/6434H/6448H/6418H/6416H b: Processor models with TDP higher than 270 W: 8490H/8468H/8460H				

 NOTE

- When a single fan is faulty, the highest operating temperature is 5°C (9°F) lower than the rated value.
- When a single fan is faulty, the system performance may be affected.
- It is recommended that servers be deployed at an interval of 1U to reduce server noise and improve server energy efficiency.

A.4 Nameplate

Certified Model	Remarks
H58H-07	Global
5885H V7	Global
Note: The nameplate depends on the actual product.	

A.5 Names and Content of Hazardous Substances

Table A-11 Names and Content of Hazardous Substances

Component		PCBA	Cables	Metal parts
Hazardous Substances	Pb	X	X	X
	Hg	O	O	O
	Cd	O	O	O
	Cr(VI)	O	O	O
	PBBs	O	O	O
	PBDEs	O	O	O
	DBP	O	O	O
	DIBP	O	O	O

	BBP	O	O	O
	DEHP	O	O	O
<ul style="list-style-type: none"> ● Note 1: <ul style="list-style-type: none"> – O: Indicate that the content of the hazardous substance contained in all of the homogenous materials in the component is within the limits of the national standard for hazardous substances in electric and electronic products. – X: Indicate that the content of the hazardous substance contained in at least one homogenous material exceeds the limits of the national standard for hazardous substances in electric and electronic products. ● Note 2: For components not listed above, their hazardous substance content is within the limits of national standard of hazardous substances in electrical and electronic products. 				

A.6 RAS Features

The server supports a variety of Reliability, Availability, and Serviceability (RAS) features. You can configure these features for better performance.

For details about RAS features, see the *Sapphire Rapids Platform Server RAS Feature Technical White Paper*.

A.7 Sensor List

Sensor	Description	Component
Inlet Temp	Air inlet temperature	Right mounting ear
Outlet Temp	Air outlet temperature	BMC card
PCH Temp	PCH bridge temperature	Mainboard
CPUN Core Temp	CPU core temperature	CPUN N indicates the CPU number. The value ranges from 1 to 4.
CPUN DTS	Difference between the real-time CPU temperature and the CPU core temperature threshold	CPUN N indicates the CPU number. The value ranges from 1 to 4.
CPUN Margin	Difference between the real-time CPU temperature and the CPU Tcontrol threshold	CPUN N indicates the CPU number. The value ranges from 1 to 4.

Sensor	Description	Component
CPUN VRD Temp	CPU VRD temperature	Mainboard N indicates the CPU number. The value ranges from 1 to 4.
CPUN MEM Temp	CPU memory module temperature	Memory module corresponding to CPU N N indicates the CPU number. The value ranges from 1 to 4.
CPUN 12V	12 V voltage supplied by the mainboard to the CPU	Mainboard N indicates the CPU number. The value ranges from 1 to 4.
CPUN VCCIN	CPU VCCIN voltage	Mainboard N indicates the CPU number. The value ranges from 1 to 4.
FANNA F Speed	Fan speed	Fan module N N indicates the fan module number. The value ranges from 1 to 4.
FANNB F Speed		
FANNA R Speed		
FANNB R Speed		
Power	Server input power	PSUs
Disks Temp	Maximum drive temperature	Drives
PCIe RAID Temp	PCIe RAID controller card temperature	RAID controller card
RaidN BBU Temp	RAID controller card capacitor temperature	RAID controller card N N indicates the PCIe slot number
PowerN	PSU input power	PSU N N indicates the PSU number. The value ranges from 1 to 4.
PCH Status	PCH chip fault diagnosis health status	Mainboard

Sensor	Description	Component
CPUN Prochot	CPU Prochot	CPUN N indicates the CPU number. The value ranges from 1 to 4.
CPUN Status	CPU status detection	CPUN N indicates the CPU number. The value ranges from 1 to 4.
FANNA Status	Fan fault status	Fan module N N indicates the fan ID. The value ranges from 1 to 4.
FANNB Status		
DIMMN	DIMM status	DIMM N N indicates the DIMM slot number.
M2 Adapter Temp	M.2 adapter Temperature	M.2 adapter card
RTC Battery	RTC battery status. An alarm is generated when the voltage is lower than 1 V.	RTC battery on the mainboard
Power Button	Power button pressed status	Mainboard and power button
Watchdog2	Watchdog	Mainboard
Mngmnt Health	Management subsystem health status	Management module
PwrOk Sig. Drop	Voltage drop status	Mainboard
PwrOn TimeOut	Power-on timeout	Mainboard
PwrCap Status	Power capping status	Mainboard
PS Redundancy	Redundancy failure due to PSU removal	PSUs
RAID Status	RAID controller card health status	RAID controller card
RAID PCIE ERR	RAID controller card health status fault diagnosis	RAID controller card
RAID Card BBU	RAID controller card BBU sensor	RAID controller card

Sensor	Description	Component
PSN VIN	PSU <i>N</i> input voltage	PSU <i>N</i> <i>N</i> indicates the PSU number. The value ranges from 1 to 4.
PSN Status	PSU fault status	PSU <i>N</i> <i>N</i> indicates the PSU number. The value ranges from 1 to 4.
PSN Fan Status	PSU fan fault status	PSU <i>N</i> <i>N</i> indicates the PSU number. The value ranges from 1 to 4.
PSN Temp	PSU temperature	PSU <i>N</i> <i>N</i> indicates the PSU number. The value ranges from 1 to 4.
PSN Status	PSU presence status	PSU <i>N</i> <i>N</i> indicates the PSU number. The value ranges from 1 to 4.
DISKN	Drive status	Drive <i>N</i> <i>N</i> indicates the drive slot number. The value ranges from 0 to 51.
PCIe RAIDN Temp	PCIe RAID controller card temperature	PCIe RAID controller card <i>N</i> <i>N</i> indicates the PCIe slot number
PCIeN OP Temp	PCIe card optical module temperature sensor	PCIe card <i>N</i> <i>N</i> indicates the PCIe slot number
PCIe NICN Temp	PCIe card chip temperature sensor	PCIe card <i>N</i> <i>N</i> indicates the PCIe slot number
1711 Core Temp	Core temperature of the BMC management chip	BMC card
PSN IIn	PSU input current	PSU <i>N</i> <i>N</i> indicates the PSU number. The value ranges from 1 to 4.

Sensor	Description	Component
PSN IOut	PSU output current	PSU <i>N</i> <i>N</i> indicates the PSU number. The value ranges from 1 to 4.
PSN Pout	PSU output power	PSU <i>N</i> <i>N</i> indicates the PSU number. The value ranges from 1 to 4.
PSN Temp	Maximum internal temperature of the PSU	PSU <i>N</i> <i>N</i> indicates the PSU number. The value ranges from 1 to 4.
PSN Inlet Temp	PSU air inlet temperature	PSU <i>N</i> <i>N</i> indicates the PSU number. The value ranges from 1 to 4.
AreaIntrusion	Listening to the unpacking action	Mainboard
OCP1 Temp	OCP card chip temperature sensor	OCP 3.0 NIC
SSD Max Temp	Maximum SSD temperature	SSD
IB <i>N</i> Temp	IB NIC temperature sensor	IB card <i>N</i> <i>N</i> indicates the PCIe slot number
PCIe <i>N</i> Temp	PCIe card chip temperature sensor	PCIe card <i>N</i> <i>N</i> indicates the PCIe slot number
SSD Disk <i>N</i> Temp	SSD temperature	NVMe SSD <i>N</i> <i>N</i> indicates the slot number of an NVMe disk
PCIe <i>N</i> Card BBU	BBU status of the PCIe RAID controller card	PCIe RAID controller card <i>N</i> <i>N</i> indicates the PCIe slot number
GPU <i>N</i> Power	GPU power	GPU card <i>N</i> <i>N</i> indicates the PCIe slot number

Sensor	Description	Component
GPU N Temp	GPU card temperature	GPU card N N indicates the PCIe slot number
GPU N HBM Temp	HBM chip temperature of the GPU card	GPU card N N indicates the PCIe slot number
MEM Power	Total power consumption of the memory module in the power-on state	Memory
CPU Power	CPU consumption of the memory module in the power-on state	Mainboard
FAN Power	Total power consumption of fans in the power-on state	Fan module
CPU Usage	CPU usage	N/A
Memory Usage	Memory usage	
ACPI State	ACPI status	
SysFWProgress	Software processes and system startup errors	
System Notice	Hot restart reminder and fault diagnosis program information collection	
System Error	System shutdown or restart. Check the background logs.	
Boot Error	Boot error	
SEL Status	SEL full or clearing events	

B Glossary

B.1 A-E

B

BMC	The baseboard management controller (BMC) complies with the Intelligent Platform Management Interface (IPMI). It collects, processes, and stores sensor signals, and monitors the operating status of components. The BMC provides the hardware status and alarm information about the managed objects to the management system so that the management system can implement unified management of the devices.
------------	--

E

ejector lever	A part on the panel of a device used to facilitate installation or removal of the device.
Ethernet	A baseband local area network (LAN) architecture developed by Xerox Corporation by partnering with Intel and DEC. Ethernet uses the Carrier Sense Multiple Access/Collision Detection (CSMA/CD) access method and allows data transfer over various cables at 10 Mbit/s. The Ethernet specification is the basis for the IEEE 802.3 standard.

B.2 F-J

G

Gigabit Ethernet (GE)	An extension and enhancement of traditional shared media Ethernet standards. It is compatible with 10 Mbit/s and 100 Mbit/s Ethernet and complies with IEEE 802.3z standards.
------------------------------	---

H

hot swap	Replacing or adding components without stopping or shutting down the system.
-----------------	--

B.3 K-O

K

KVM	A hardware device that provides public keyboard, video and mouse (KVM).
------------	---

B.4 P-T

P

panel	An external component (including but not limited to ejector levers, indicators, and ports) on the front or rear of the server. It seals the front and rear of the chassis to ensure optimal ventilation and electromagnetic compatibility (EMC).
Peripheral Component Interconnect Express (PCIe)	A computer bus PCI, which uses the existing PCI programming concepts and communication standards, but builds a faster serial communication system. Intel is the main sponsor for PCIe. PCIe is used only for internal interconnection. A PCI system can be transformed to a PCIe system by modifying the physical layer instead of software. PCIe delivers a faster speed and can replace almost all AGP and PCI buses.

R

redundancy	A mechanism that allows a backup device to automatically take over services from a faulty device to ensure uninterrupted running of the system.
redundant array of independent disks (RAID)	A storage technology that combines multiple physical drives into a logical unit for the purposes of data redundancy and performance improvement.

S

server	A special computer that provides services for clients over a network.
Standby 12V Out (SV12)	Standby 12V output of the PSU.
system event log (SEL)	Event records stored in the system used for subsequent fault diagnosis and system recovery.

B.5 U-Z

U

U	A unit defined in International Electrotechnical Commission (IEC) 60297-1 to measure the height of a cabinet, chassis, or subrack. 1U = 44.45 mm (1.75 in).
UltraPath Interconnect (UPI)	A point-to-point processor interconnect developed by Intel.

C Acronyms and Abbreviations

C.1 A-E

A

AC	alternating current
AES	Advanced Encryption Standard New Instruction Set
ARP	Address Resolution Protocol
AVX	Advanced Vector Extensions

B

BBU	backup battery unit
BIOS	Basic Input/Output System
BMC	baseboard management controller

C

CCC	China Compulsory Certification
CD	calendar day
CE	Conformite Europeenne
CIM	Common Information Model
CLI	command-line interface

D

DC	direct current
DDR5	Double Data Rate 5
DDDC	double device data correction
DEMT	Dynamic Energy Management Technology
DIMM	dual in-line memory module
DRAM	dynamic random-access memory
DVD	digital video disc

E

ECC	error checking and correcting
ECMA	European Computer Manufacturer Association
EDB	Execute Disable Bit
EID	enclosure ID
EN	European Efficiency
ERP	enterprise resource planning
ETS	European Telecommunication Standards

C.2 F-J

F

FB-DIMM	Fully Buffered DIMM
FC	Fiber Channel
FCC	Federal Communications Commission
FCoE	Fibre Channel over Ethernet
FTP	File Transfer Protocol

G

GE	Gigabit Ethernet
-----------	------------------

GPIO	General Purpose Input/Output
GPU	graphics processing unit

H

HA	high availability
HBM	high bandwidth memory
HDD	hard disk drive
HPC	high-performance computing
HTTP	Hypertext Transfer Protocol
HTTPS	Hypertext Transfer Protocol Secure

I

iBMC	intelligent baseboard management controller
IC	Industry Canada
ICMP	Internet Control Message Protocol
IDC	Internet Data Center
IEC	International Electrotechnical Commission
IEEE	Institute of Electrical and Electronics Engineers
IGMP	Internet Group Message Protocol
IOPS	input/output operations per second
IP	Internet Protocol
IPC	Intelligent Power Capability
IPMB	Intelligent Platform Management Bus
IPMI	Intelligent Platform Management Interface

C.3 K-O

K

KVM	keyboard, video, and mouse
------------	----------------------------

L

LC	Lucent Connector
LRDIMM	load-reduced dual in-line memory module
LED	light emitting diode
LOM	LAN on motherboard

M

MAC	media access control
MMC	module management controller

N

NBD	next business day
NC-SI	Network Controller Sideband Interface

O

OCP	Open Compute Project
------------	----------------------

C.4 P-T

P

PCIe	Peripheral Component Interconnect Express
PDU	power distribution unit
PHY	physical layer
PMBUS	power management bus
POK	Power OK
PWM	pulse-width modulation
PXE	Preboot Execution Environment

R

RAID	redundant array of independent disks
RAS	reliability, availability and serviceability
RDIMM	registered dual in-line memory module
REACH	Registration Evaluation and Authorization of Chemicals
RJ45	registered jack 45
RoHS	Restriction of the Use of Certain Hazardous Substances in Electrical and Electronic Equipment

S

SAS	Serial Attached Small Computer System Interface
SATA	Serial Advanced Technology Attachment
SCM	supply chain management
SDDC	single device data correction
SERDES	serializer/deserializer
SGMII	serial gigabit media independent interface
SMI	serial management interface
SMTP	Simple Mail Transfer Protocol
SNMP	Simple Network Management Protocol
SOL	serial over LAN
SONCAP	Standards Organization of Nigeria-Conformity Assessment Program
SSD	solid-state drive
SSE	Streaming SIMD Extension

T

TACH	tachometer signal
TBT	Turbo Boost Technology
TCG	Trusted Computing Group
TCM	trusted cryptography module
TCO	total cost of ownership

TDP	thermal design power
TELNET	Telecommunication Network Protocol
TET	Trusted Execution Technology
TFM	TransFlash module
TFTP	Trivial File Transfer Protocol
TOE	TCP offload engine
TPM	trusted platform module

C.5 U-Z

U

UBC	Union Bus Connector
UBC DD	Union Bus Connector Double Density
UDIMM	unbuffered dual in-line memory module
UEFI	Unified Extensible Firmware Interface
UID	unit identification light
UL	Underwriter Laboratories Inc.
UPI	UltraPath Interconnect
USB	Universal Serial Bus

V

VCCI	Voluntary Control Council for Interference by Information Technology Equipment
VGA	Video Graphics Array
VLAN	virtual local area network
VRD	voltage regulator-down
VROC	Virtual RAID on CPU

W

WEEE	waste electrical and electronic equipment
-------------	---

WSMAN	Web Service Management
--------------	------------------------